



Adaptive radiation in miniature: the minute salamanders of the Mexican highlands (Amphibia: Plethodontidae: *Thorius*)

SEAN M. ROVITO^{1,2}, GABRIELA PARRA-OLEA^{1*}, JAMES HANKEN³, RONALD M. BONETT⁴ and DAVID B. WAKE²

¹*Departamento de Zoología, Instituto de Biología, Universidad Nacional Autónoma de México, AP 70-153, CP 04510, Ciudad Universitaria, México D.F., México*

²*Department of Integrative Biology and Museum of Vertebrate Zoology, University of California, Berkeley, CA 94720-3160, USA*

³*Department of Organismic and Evolutionary Biology and Museum of Comparative Zoology, Harvard University, 26 Oxford St., Cambridge, MA 02138, USA*

⁴*Department of Biological Science, University of Tulsa, 800 S Tucker Drive, Tulsa, OK 74104, USA*

Received 15 October 2012; revised 31 January 2013; accepted for publication 1 February 2013

The small size and apparent external morphological similarity of the minute salamanders of the genus *Thorius* have long hindered evolutionary studies of the group. We estimate gene and species trees within the genus using mitochondrial and nuclear DNA from nearly all named and many candidate species and find three main clades. We use this phylogenetic hypothesis to examine patterns of morphological evolution and species coexistence across central and southern Mexico and to test alternative hypotheses of lineage divergence with and without ecomorphological divergence. Sympatric species differ in body size more than expected after accounting for phylogenetic relationship, and morphological traits show no significant phylogenetic signal. Sympatric species tend to differ in a combination of body size, presence or absence of maxillary teeth, and relative limb or tail length, even when they are close relatives. Sister species of *Thorius* tend to occupy climatically similar environments, which suggests that divergence across climatic gradients does not drive species formation in the genus. Rather than being an example of cryptic species formation, *Thorius* more closely resembles an adaptive radiation, with ecomorphological divergence that is bounded by organism-level constraints. © 2013 The Linnean Society of London, *Biological Journal of the Linnean Society*, 2013, **109**, 622–643.

ADDITIONAL KEYWORDS: biogeography – diversification – morphology – phylogeny – species formation – systematics.

INTRODUCTION

Ongoing discovery and description of new species, particularly in the tropics, complicate understanding the factors that promote diversification and lead to variation in species diversity across regions. Many new species, especially those that are difficult to distinguish based on morphology, are first identified using molecular data (Hanken, 1983a; Bickford *et al.*,

2006; Foquet *et al.*, 2007). Cryptic species – two or more species that are very similar in external morphology and previously regarded as a single species (Bickford *et al.*, 2006) – may represent a significant proportion of the total diversity of some groups and need to be accounted for in broad-scale macroecological and evolutionary analyses. Miniaturized species can be particularly problematic, as miniaturization often leads to a reduction in, or even absence of, morphological characters used to differentiate larger species (Hanken & Wake, 1993). Additionally, the small size of miniaturized species can make them

*Corresponding author. E-mail: gparra@ibiologia.unam.mx

appear superficially similar, hindering a recognition of subtle but significant morphological differences that may exist.

The evolutionary role of miniaturization and its often dramatic consequences for vertebrate morphology have been extensively documented and discussed (Hanken, 1985; Hanken & Wake, 1993, and references therein; Schmidt & Wake, 1997; Ruber *et al.*, 2007). Miniaturization may yield convergent or homoplastic morphologies but also novel body plans (Hanken & Wake, 1993). In some groups, small body size results in limited dispersal capabilities and reduced physiological tolerances, which lead to smaller and more strongly fragmented ranges; these, in turn, may promote geographical isolation and ultimately species formation (Wollenberg *et al.*, 2011).

The minute salamanders of the Mexican plethodontid genus *Thorius* exhibit extreme miniaturization. Several species have adult body lengths less than 20 mm, making them the smallest terrestrial tailed vertebrates (Hanken & Wake, 1998). All species of *Thorius* are characterized by tiny body size, extreme skeletal reduction, and unique features of the skeleton, including unusual ossifications of many elements that remain cartilaginous in other salamanders; these features readily distinguish *Thorius* from all other salamanders (Hanken, 1982, 1983b, 1984). At the same time, external morphology appears to be highly conservative among members of this clade, leaving few obvious characters by which species may be distinguished.

The systematic position of *Thorius* has been a matter of controversy since its original description (Cope, 1869), as have taxonomic relationships within the genus (Hanken, 1983a, 1984). Some workers considered *Thorius* sufficiently distinctive to warrant its own family, Thoriidae (Cope, 1869, 1889; Hall, 1952), whereas Dunn (1926) included it together with all other neotropical plethodontid species in a single genus, *Oedipus*. Currently, *Thorius* is recognized as one of 12 genera within the plethodontid tribe Bolitoglossini (Wake, 2012). Initial morphological studies of *Thorius* (Taylor, 1941, 1944) revealed relatively limited species diversity. The description of two new species by Gehlbach (1959) brought the number of recognized species to nine, and that number remained unchanged for more than three decades. Molecular (allozyme) studies uncovered surprising levels of genetic differentiation among populations, and these data were used to delimit and describe additional species and develop phylogenetic hypotheses (Hanken, 1983a; Hanken & Wake, 1994, 1998, 2001; Hanken, Wake & Freeman, 1999). The genus currently contains 24 species (AmphibiaWeb, 2013), including *Thorius adelos*, which until recently was assigned to *Cryptotriton* (Wake *et al.*, 2012). However,

to date almost no DNA sequence data have been available for *Thorius*.

Allozyme studies showed that as many as three sympatric species of *Thorius* are present at some localities, with high species turnover across small spatial scales (Hanken, 1983a). Many of these species show extensive genetic divergence. The large number of such species distributed over short geographical distances and along elevational gradients in south-central Mexico (Hanken, 1983a; Hanken & Wake, 1994, 1998) raises the question of what factors generated this high species diversity. Adaptation to different climatic regimes over elevational gradients could explain this buildup of species (Kozak & Wiens, 2007), as could allopatric divergence due to low vagility (Jockusch & Wake, 2002). At the same time, it is unclear how multiple sympatric species can coexist at a single locality in spite of the apparently limited morphological differences among them.

In this study, we report DNA sequences from three mitochondrial genes and one nuclear gene and use them to generate a phylogenetic hypothesis for *Thorius*. We include nearly all valid, named taxa as well as several candidate species uncovered by using allozymes, DNA sequences, or both. A comparative morphological database for sympatric species and for several sister-species pairs is also utilized. With this foundation, we examine diversification of the clade with special focus on how local communities of salamanders have evolved. We also examine climatic niche divergence between sister species, measured by degree of overlap in temperature range, in order to understand the ecological context of species divergence and how species formation in *Thorius* compares with patterns in other tropical and temperate plethodontid salamanders. Differences in microhabitat use between sympatric species – terrestrial cover objects versus arboreal bromeliads – are considered in order to capture another aspect of the ecological differences between species.

By using a relatively robust phylogenetic hypothesis based on molecular data, we examine patterns of body size evolution in *Thorius* to test the hypothesis that, after accounting for shared evolutionary history, disparity in body size is greater between sympatric species than between allopatric species. We also test the degree to which phylogenetic history explains divergence in body size and other morphological characters. Ecomorphological differentiation in both body size and other characters is expected under a scenario of adaptive divergence and has been observed in other salamander genera (e.g. *Desmognathus*; Kozak *et al.*, 2005). By contrast, other plethodontid salamanders, such as the *Plethodon glutinosus* species group (Kozak, Weisrock & Larson, 2006) and *Batrachoseps* (Wake, 2006), have been offered as examples of non-

adaptive radiation (Gittenberger, 1991), in which species divergence is not accompanied by major morphological divergence and species generally occupy similar ecological niches. Phylogenetic and morphological analyses of *Thorius* are used to test the alternative hypotheses of species proliferation without much adaptive divergence, i.e. a non-adaptive radiation, versus an adaptive radiation in miniature.

MATERIAL AND METHODS

SAMPLING DESIGN

We obtained partial DNA sequences of three mitochondrial genes – large subunit ribosomal RNA (16S, 538 bp), cytochrome *b* (*cyt b*, 570 bp), and NADH dehydrogenase subunit 4 (ND4, 564 bp) – for 62 specimens of 24 named species plus seven candidate species that await formal description (see below; Table 1; Fig. 1). A single specimen of *Thorius adelos* (MVZ 208582), collected by an entomologist and fixed using an unknown technique probably without formalin, was also sequenced. The generic placement of this species has been problematic since its original description (Papenfuss & Wake, 1987; García-París & Wake, 2000), but Wake *et al.* (2012) reassigned it to *Thorius* based on morphological and allozyme data. We also obtained sequences of the nuclear gene RAG-1 (816 bp) for 44 specimens of 24 taxa (Table 1). All sequences obtained for this study are deposited in GenBank (Table 1).

AMPLIFICATION AND SEQUENCING

Tissues were obtained from various sources, including recent field collections and donations from several researchers and institutions (see Acknowledgements). Whole genomic DNA was extracted from small amounts of frozen or ethanol-preserved tissues using Qiagen DNeasy tissue kits (Qiagen, Valencia, CA, USA) following the manufacturer's protocol. PCR amplification was done using the primers MVZ15 and MVZ18 for *cyt b* (Moritz, Schneider & Wake, 1992), 16Sar and 16Sbr for 16S (Palumbi *et al.*, 1991), ND4 (Arévalo, Davis & Sites, 1994), and primer gpNDLeu1 (5'-GTGAATGTTCTCCTGAGATTAGTTCYGG-3') for ND4, and Rag1-BolitoF (5'-CTTGAAGTAGGGGCATACTCAGAAC-3') and Rag1-BolitoR (5'-TGCCTGGCATTTCATTTCCGGAAACG-3') (Elmer *et al.*, 2013) or Amp-RAG1-F1 and Amp-RAG1-R (San Mauro *et al.*, 2004) for RAG-1. PCR reactions consisted of 38 cycles with a denaturing temperature of 92 °C (1 min), annealing at 48–50 °C (1 min), and extension at 72 °C (1 min) on a Techne PHC-1 thermocycler. PCR reactions were run in a total volume of 25 µL, using 0.5 pmol of each primer. To check for contamination, we ran negative controls

with each reaction adding water instead of DNA. For the single sample of *Thorius adelos*, a shorter fragment of 16S (209 bp) was also sequenced using primers MVZ117 and primer Pleth16SiR1 (5'-GTTTAAAGCTCCAYAGGGTCTTC-3'). Only a short fragment of 16S could be sequenced because tissue was taken from a preserved museum specimen (probably not formalin-fixed) and longer fragments failed to amplify. The PCR product for *T. adelos* was cloned using a TA Cloning kit (Sigma-Aldrich, St. Louis, MO, USA) to separate its amplicons from potential contaminants derived from humans or other salamanders. The majority of the resulting clones were distinct from all other *Thorius* in the dataset.

Double-strand templates were cleaned using a QIAquick PCR purification kit (Qiagen). We used 5.5 µL of PCR product as the template for cycle-sequencing reactions in a 10-µL total volume with the Perkin-Elmer Ready Reaction Kit to incorporate dye-labelled dideoxy terminators. Thermal cycling was performed using standard conditions. Products were purified with an ethanol precipitation and sequenced in an ABI 377 or ABI 3730 DNA automated sequencer (Applied Biosystems, Foster City, CA, USA).

SEQUENCE ALIGNMENT AND ANALYSES

Sequences were edited using Sequencher 4.7 (Gene Codes, Ann Arbor, MI, USA) and aligned using MUSCLE 3.6 (Edgar, 2004). Phylogenetic analyses were run with multiple partitioning strategies; the Akaike Information Criterion (AIC) in the program MrModeltest 2.2 (Nylander, 2004) was used to select a nucleotide substitution model for each partition. The following substitution models were used in the final partitioning scheme: GTR+I+G for 16S, ND4 codon positions 2 and 3; GTR+G for ND4 codon position 1 and *cyt b* codon position 3; HKY+I+G for *cyt b* codon position 1; HKY+G for *cyt b* codon position 2, RAG1 codon positions 1 and 3; and GTR for RAG1 codon position 2.

Both maximum-likelihood (ML) and Bayesian phylogenetic analyses were performed for mtDNA and RAG1 data sets. Bayesian analyses were run using the program MrBayes 3.0.4 (Huelsenbeck & Ronquist, 2001). Metropolis-coupled Markov Chain Monte Carlo (MCMCMC) analyses were run for 20 000 000 generations, with four chains (one cold, three heated to default temperature) and two runs per analysis. Chains were sampled every 1000 generations; the first 5000 samples were discarded as burn-in. Convergence of MCMCMC runs was assessed using the Compare and Sliding Window plots in AWTY (Nylander *et al.*, 2008). Three partitioning strategies were compared for mtDNA: one partition (all fragments concatenated), three partitions (16S, ND4,

Table 1. Voucher information and GenBank numbers for specimens of *Thorius* used in phylogenetic analyses. All localities are in Mexico.

Species	Locality	Voucher Number	GenBank 16S	GenBank ND4	GenBank cyt <i>b</i>	GenBank RAG-1
<i>T. adelos</i>	Oaxaca: La Esperanza	MVZ 208582	KC884064	—	—	—
<i>T. arboreus</i>	Oaxaca: 5 km SW (by rd) La Esperanza	IBH 22720	KC884060	—	KC884119	KC884221
<i>T. aureus</i>	Oaxaca: 1 km N from El Mirador, Cerro Pelón	IBH 22356	KC884006	KC884123	KC884065	KC884197
<i>T. boreas</i>	Oaxaca: 24.8 km N Guelatao, Llano de las Flores	IBH 22339	KC884007	KC884124	KC884066	KC884198
<i>T. boreas</i>	Oaxaca: 50 km N Guelatao, Cerro Pelón	IBH 22324	KC884008	KC884125	KC884067	KC884199
<i>T. dubitus</i>	Veracruz: El Sumidero, Puerto del Aire	GP 0554, MCZ A-137386	DQ640055, KC884009	KC884126, KC884127	DQ640019, KC884068	KC884200,
<i>T. grandis</i>	Guerrero: Puerto del Gallo	MZFC 27548, 27549, 27550	—, —, KC884056	—, —, KC884176	—, —, KC884115	—, KC884180, KC884181,
<i>T. insperatus</i>	Oaxaca: 1.2 km N La Esperanza	IBH 22901	KC884061	—	KC884120	—
<i>T. lunaris</i>	Puebla: 13 km above Atzitzintla on road to El Berro	IBH 22341	KC884010	KC884128	KC884069	KC884201
<i>T. macdougalli</i>	Oaxaca: 24.8 km N Guelatao, Llano de las Flores	IBH 22900	KC884012	KC884130	KC884071	KC884202
<i>T. macdougalli</i>	Oaxaca: 35 km N Guelatao	IBH 22890	KC884013	KC884131	KC884072	KC884187
<i>T. macdougalli</i>	Oaxaca: 50 km N Guelatao, Cerro Pelón	IBH 22895	KC884011	KC884129	KC884070	KC884186
<i>T. magnipes</i>	Puebla: Lagunas de San Bernardino	IBH 22918	KC884063	—	KC884122	KC884191
<i>T. maxillabrochus</i>	Oaxaca: 600 m S Teotitlán del Camino, Puerto de Soledad	MCZ A-148743	KC884046	KC884166	KC884105	KC884212
<i>T. maxillabrochus</i>	Puebla: 5.3 km S Zoquitlán	MVZ 269314, 269315, 269316	KC884045, KC884043, KC884044	KC884165, KC884163, KC884164	KC884104, KC884102, KC884103	KC884182, —, —
<i>T. maxillabrochus</i>	Oaxaca: 2 km NW Puerto de Soledad	MCZ A-148749	KC884048	KC884168	KC884107	—
<i>T. maxillabrochus</i>	Oaxaca: 1 km NW Puerto de Soledad	MCZ A-148750, GP 0665	KC884049, KC884050	KC884169, KC884170	KC884108, KC884109	—, KC884219
<i>T. minutissimus</i>	Oaxaca: 1.1 km W Santo Tomás Teipan	IBH 23011, 23012	DQ640057, KC884015	KC884133, KC884134	DQ640021, KC884074	KC884204, KC884194
<i>T. minydemus</i>	Veracruz: 6 km ENE Chiconquiaco, Loma Alta microwave station	MVZ 229269	KC884041	KC884161	KC884100	—
<i>T. munificus</i>	Veracruz: 6 km W Las Vigas on Hwy 140	GP 0203	KC884014	KC884132	KC884073	KC884203
<i>T. narisovalis</i>	Oaxaca: 12 km W La Cumbre, Cerro San Felipe	IBH 26500	KC884018	KC884137	KC884077	KC884211
<i>T. narisovalis</i>	Oaxaca: 6.6 km W La Cumbre, Cerro San Felipe	IBH 22346	KC884047	KC884167	KC884106	KC884206
<i>T. narisovalis</i>	Oaxaca: 4.2 km W La Cumbre, Cerro San Felipe	IBH 22833	KC884019	KC884138	KC884078	—
<i>T. narisovalis</i>	Oaxaca: 10 km NE Cuajimoloya	IBH 22988	KC884016	KC884135	KC884075	KC884207
<i>T. narisovalis</i>	Oaxaca: 29 km SSE Tlaxiaco	GP 0285	KC884017	KC884136	KC884076	—

Table 1. *Continued*

Species	Locality	Voucher Number	GenBank 16S	GenBank ND4	GenBank cyt <i>b</i>	GenBank RAG-1
<i>T. omiltemi</i>	Guerrero: 1 km W Carrizal de Bravo	MVZ 269308	—	KC884140	KC884080	KC884208
<i>T. omiltemi</i>	Guerrero: 1.5 km W Carrizal de Bravo	MVZ 269311	—	—	—	KC884192
<i>T. omiltemi</i>	Guerrero: 5 km W Carrizal de Bravo	MVZ 269309	KC884020	KC884139	KC884079	—
<i>T. omiltemi</i>	Guerrero: 6 km W Carrizal de Bravo	MVZ 269310	—	—	—	KC884193
<i>T. papaloae</i>	Oaxaca: 5 km NW Concepción Pápalo	IBH 22355	KC884021	KC884141	KC884081	KC884209
<i>T. papaloae</i>	Oaxaca: Loma el Viento, San Isidro Buenos Aires	MCZ A-148751–148753	KC884053–KC884055	KC884173–KC884175	KC884112–KC884114	KC884214, —, —
<i>T. pennatulus</i>	Veraacruz: Progreso, Municipio de Atoyac	IBH 26499	KC884022	KC884142	KC884082	KC884210
<i>T. pulmonaris</i>	Oaxaca: 5 km S La Cumbre on Hwy 175	MCZ A-148742	KC884042	KC884162	KC884101	—
<i>T. schmidti</i>	Puebla: 7.3 km W Zoquitlán	MVZ 269312, 269313	KC884025, KC884024	KC884145, KC884144	KC884085, KC884084	—, KC884195
<i>T. smithi</i>	Oaxaca: 7.9 km N Hwy 175 on road to San Isidro Yolo	IBH 26615	KC884062	—	KC884121	—
<i>T. spilogaster</i>	Veraacruz: 1 km W Coiyachapa	IBH 22975	KC884027	KC884147	KC884087	KC884218
<i>T. troglodytes</i>	Veraacruz: 1 km S Puerto del Aire	IBH 22981	KC884028	KC884148	KC614433	KC614460
<i>T. sp. 1</i>	Oaxaca: 600 m S Teotitlán del Camino, Puerto de Soledad	GP 0099	KC884026	KC884146	KC884086	—
<i>T. sp. 2</i>	Oaxaca: 13.1 km W La Cumbre, road to Zoquiapan, Cerro San Felipe	GP 0347	KC884023	KC884143	KC884083	KC884190
<i>T. sp. 2</i>	Oaxaca: 14 km NW La Cumbre, road to Nuevo Zoquiapan, Cerro San Felipe	MCZ A-148756, 148757	—, KC884059	—, KC884179	—, KC884118	KC884196, —
<i>T. sp. 2</i>	Oaxaca: 500 m E San Miguel Huautla	EBUAP 1954–1956	KC884032–KC884034	KC884152–KC884154	KC884091–KC884093	KC884183, KC884184, —
<i>T. sp. 3</i>	Oaxaca: 24 km W Zaachila	MCZ A-148759, 148760	KC884057, KC884058	KC884177, KC884178	KC884116, KC884117	KC884216, —
<i>T. sp. 4</i>	Oaxaca: 16.7 km SE Sola de Vega	IBH 13998	KC884029	KC884149	KC884088	KC884205
<i>T. sp. 4</i>	Oaxaca: La Cofradia, Municipio San Pedro el Alto, beyond San Vicente Lachixio	MCZ A-148744	KC884037	KC884157	KC884096	KC884217
<i>T. sp. 5</i>	Oaxaca: 27.3 km SSE Tlaxiaco	MCZ A-148745, 148746	KC884039, KC884040	KC884159, KC884160	KC884098, KC884099	KC884220, —
<i>T. sp. 5</i>	Oaxaca: 13 km W San Vicente Lachixio	MCZ A-148747	KC884038	KC884158	KC884097	KC884185
<i>T. sp. 6</i>	Oaxaca: 1.7 km N San Miguel Suchixtepec	IBH 13995, 13996	KC884035, KC884036	KC884155, KC884156	KC884094, KC884095	KC884213, —
<i>T. sp. 7</i>	Oaxaca: 20 km N San Juan del Estado	MCZ A-148754, 148755	KC884052, KC884051	KC884172, KC884171	KC884111, KC884110	KC884215, —
<i>T. sp. 7</i>	Oaxaca: San Juan Bautista Atlatluha, Sierra de Monteflor	EBUAP 2263, 2264	KC884030, KC884031	KC884150, KC884151	KC884089, KC884090	KC884189, KC884188
<i>Batrachoseps attenuatus</i>	United States: Oregon	MVZ 230761	NC_006430	NC_006340	NC_006340	—
<i>Batrachoseps major</i>	United States: California	TWR553	—	AY691798	AY691754	AY650126

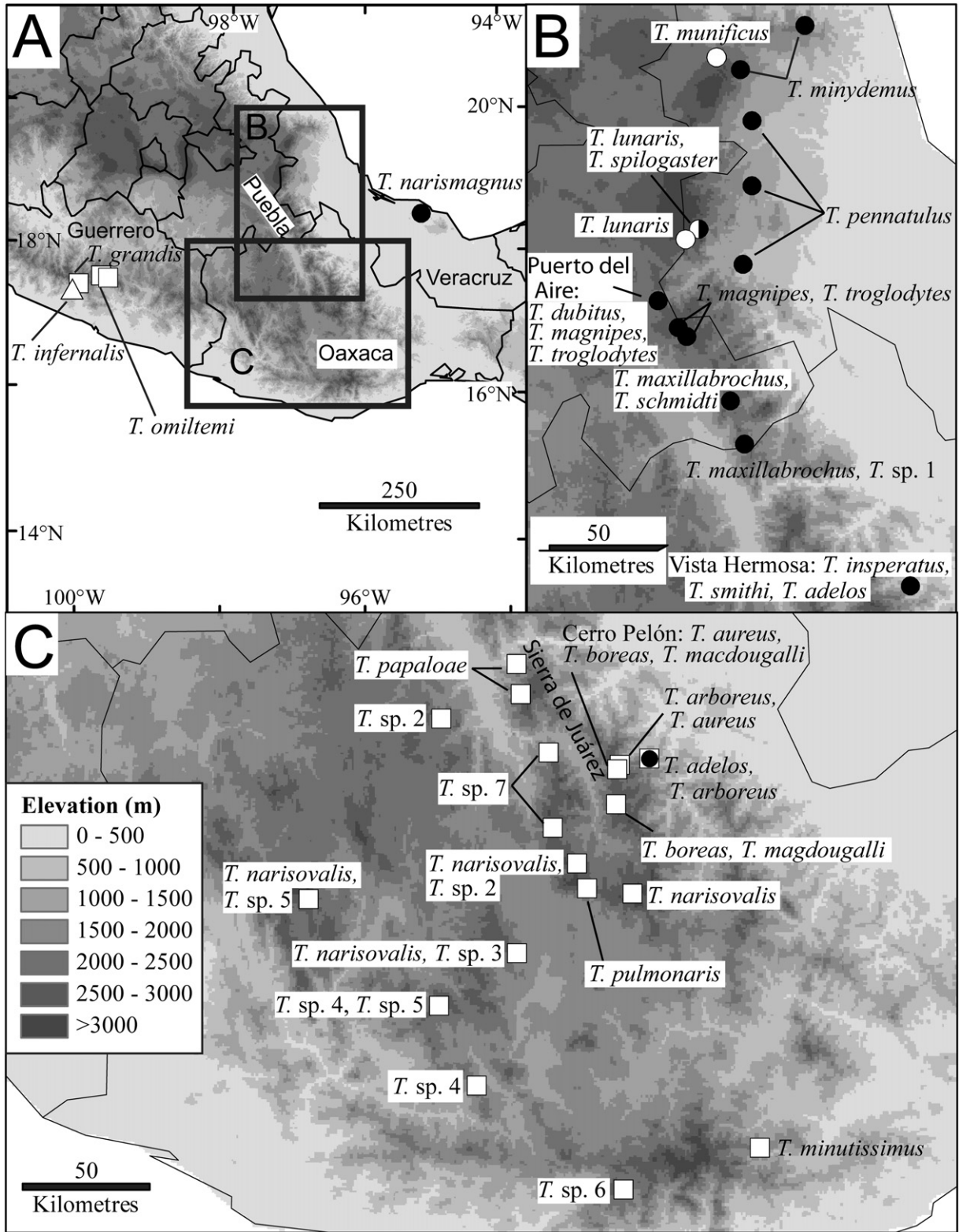

Figure 1. Distribution of *Thorius* in Mexico. A, overview of species distributions in southern Mexico, showing individual species in Guerrero and eastern Veracruz. B, species from Veracruz, Puebla, and northern Oaxaca. C, additional species from Oaxaca. White circles, species from clade 1; black circles, species from clade 2; white squares, species from clade 3. *Thorius infernalis*, not included in our phylogeny, is shown by a white triangle.

cyt *b*) and seven partitions (16S, ND4 codon positions 1, 2 and 3, and cyt *b* codon positions 1, 2 and 3). Bayes factors, calculated from the harmonic mean of the likelihood, were used to compare partitioning strategies (Brandley, Schmitz & Reeder, 2005). Bayes factors supported the seven-partition strategy for mtDNA (2ln Bayes factors: seven vs. three partitions = 1014, seven partitions vs. one partition = 1242, three partitions vs. one partition = 227) and the one-partition strategy for RAG1 (2ln Bayes factor three partitions vs. one partition = -49.5). The program Tracer v.1.5 (Rambaut & Drummond, 2007) was used to check Effective Sample Size (ESS) values and posterior distributions of all parameters.

ML analyses were conducted in the program RAxML 7.04 (Stamatakis, 2006), with the GTR+I+G model for mtDNA partitions and the GTR+G model for RAG1; RAxML does not implement less complex models than GTR, so models were chosen to match those selected by MrModelTest as closely as possible. The same partitioning strategies used in Bayesian analyses were also used for ML analyses. One thousand bootstrap replicates were conducted to assess nodal support. *Batrachoseps attenuatus* was used as an outgroup for mtDNA phylogenetic analyses and *B. major* for RAG1 phylogenetic analyses; no single individual or species of *Batrachoseps* had available sequence data for all four fragments used in this study. These outgroups were chosen because *Batrachoseps* has been shown to be the sister group of the tropical bolitoglossines in recent multilocus phylogenetic analyses (Vieites, Min & Wake, 2007; Pyron & Wiens, 2011; Vieites *et al.*, 2011).

While the topology of individual gene trees depends on the underlying species tree, no single gene tree should necessarily be expected to exactly match the topology of the species tree because of coalescent stochasticity (Pamilo & Nei, 1988; Rosenberg & Nordborg, 2002). Concatenation of multiple loci for phylogenetic analysis can produce misleading results in some cases (Degnan & Rosenberg, 2006), particularly when incomplete lineage sorting produces gene trees that are incongruent with the underlying species trees (Edwards, Liu & Pearl, 2007). To estimate the underlying species tree with both loci (mtDNA and RAG1), we used the *BEAST method implemented in BEAST v.1.7.1 (Drummond & Rambaut, 2007; Heled & Drummond, 2010). This program uses a multispecies coalescent approach implemented in a Bayesian framework to infer jointly a species tree, individual gene trees, and population sizes using a multilocus data set. Only species that had sequence data for both mtDNA and RAG1 were included in the analysis. Gametic phase of RAG1 sequences was resolved computationally using PHASE v 2.1 (Stephens, Smith & Donnelly, 2001).

The single breakpoint method (SBP; Pond *et al.*, 2006) implemented in the HyPhy package (Pond, Frost & Muse, 2005) on the Datamonkey webserver (Pond & Frost, 2005) with the small sample size AIC (cAIC) criterion was used to test for intralocus recombination in the RAG1 data. No evidence of recombination was detected. The same partitioning strategies and nucleotide substitution models were used as in the MrBayes analyses, and a Yule process was used for the species-tree prior. The MCMC was run for 200 000 000 generations, sampled every 1000 generations, and the first 50 000 samples were discarded as burn-in. ESS values and posterior distributions of analysis parameters were examined using Tracer v.1.5 (Rambaut & Drummond, 2007). Even though *BEAST does not require designation of an outgroup, sequences of *Batrachoseps major* were included as an outgroup. Although no 16S sequence was available for this sample of *B. major*, it was the only individual with available sequence for both mtDNA (ND4 and cyt *b*) and RAG1.

MORPHOLOGICAL COMPARISONS

Morphological data for named species of *Thorius* were compiled from published species descriptions and other taxonomic studies (Hanken & Wake, 1994, 1998, 2001; Hanken *et al.*, 1999). For several candidate species, measurements of museum specimens were taken using dial calipers; tooth counts were made using a dissecting microscope. All measurements from this and published studies were taken on formalin-fixed museum specimens by the same two authors (D.B.W. and J.H.) using a standardized methodology. The following measurements and characters were compared among species: snout-vent length/tail length (SL/TL); limb interval (LI), or relative limb length, measured as the number of costal folds that remain uncovered when fore- and hind limbs are appressed to the side of the body; number of maxillary teeth; and nostril shape, measured as the ratio of length to width.

CLIMATIC COMPARISONS

We calculated the extent of climatic niche overlap between pairs of sister species, measured using temperature, to understand the role that climatic niche divergence has played in species formation within *Thorius*. First, specimen records were compiled from HerpNet (<http://www.herpnet.org>), as well as from the authors' field catalogues. The following eight pairs of sister species, determined from phylogenetic analysis of mtDNA sequence data and the multilocus species-tree analysis, were included: *T. lunaris*-*T. munificus*, *T. magnipes*-*T. schmidtii*,

T. pennatulus–*T. smithi*, *T. minydemus*–*T. spilogaster*, *T. minutissimus*–*T. narisovalis*, *T. aureus*–*T. boreas*, *T. arboreus*–*T. macdougalli*, *T. grandis*–*T. omiltemi*, and *T. papaloe*–*T. sp 7*. Most of these species have altitudinal ranges of several hundred metres; the species with the largest altitudinal range is *T. pennatulus* (1000 m); *T. minutissimus* is known from a single locality. While some species pairs are largely sympatric (*T. aureus* and *T. boreas*), or parapatric (*T. arboreus* and *T. macdougalli*), others are separated by large distances (*T. pennatulus* and *T. smithi*, c. 150 km).

To remove misidentifications or improperly georeferenced localities, records for each species were first checked to identify collecting localities outside the species' known distribution. Specimens without spatial coordinates were georeferenced using Google Earth. Additionally, we obtained from HerpNet records for the 14 pairs of sister species of neotropical bolitoglossines used by Kozak & Wiens (2007) in their comparison of climatic niche divergence between tropical and temperate plethodontid salamanders, which did not include *Thorius*. We checked localities of all species, supplemented these records with recently collected specimens, and corrected inaccurate georeferences based on our knowledge of collecting sites and salamander distributions. Maximum and minimum values of mean monthly temperature for each record were obtained using 30 arc-second resolution (approximately 1 km) data from the WorldClim climate data layers (Hijmans *et al.*, 2005), and mean monthly minimum and maximum values were calculated for each species. Climatic overlap between each pair of sister species was calculated using R (R Core Development Team, 2012) following the method of Kozak & Wiens (2007). Briefly, this method calculates mean maximum and minimum temperatures across all localities for a species and uses the difference between these values as the temperature range for that species for that month. Overlap between the temperature ranges of two sister species (in °C) is divided by the temperature range of each species, and those two values are averaged to give the degree of temperature overlap for that month. Finally, values for each month are summed over the year to give the final overlap index, which ranges from 0 to 12. We compared climatic overlap values for *Thorius* with those for other tropical bolitoglossines using a Mann–Whitney *U*-test. If low dispersal ability led to population vicariance during periods of environmental change, we would expect sister species of *Thorius* to exhibit substantial climatic overlap, as is seen in temperate plethodontids (Kozak & Wiens, 2007). Alternatively, if divergence across climatic gradients or into new environments was an important factor in the diversification of *Thorius*, we would

expect sister species to show lower levels of climatic overlap.

While monthly temperature range captures only one aspect of a species' climatic niche, adaptation to different temperature regimes has been the focus of hypotheses that relate climatic niche divergence to divergence between species or populations (Janzen, 1967; Ghalambor *et al.*, 2006; Kozak & Wiens, 2007). Temperature is highly correlated with elevation and thus changes in a predictable way across elevational gradients, whereas the relationship between elevation and other variables such as precipitation may be more complex. Because we are interested in how past climatic changes may have led either to range fragmentation and divergence across climatic barriers or to divergence along elevational gradients, we chose to focus this analysis on temperature. Steep elevational gradients, such as those common in the Oaxaca highlands and the eastern terminus of the Trans-Mexican Volcanic Belt of Veracruz, mean that sites separated by only a few kilometres may differ substantially in temperature. Consequently, even sister species of *Thorius* found in adjacent localities may experience markedly different temperature regimes.

SPECIES DELIMITATION

We use an integrative taxonomy approach that incorporates morphological characters, molecular data, and geography to identify population-level lineages of *Thorius* that are diagnosable with multiple lines of evidence (de Quieroz, 1998; Padial *et al.*, 2010). We regard as candidate species (Vences & Wake, 2007) those divergent lineages that show morphological character differences from and/or sympatry with closely related species.

Recognition that *Thorius* contains numerous divergent lineages and relatively high species diversity emerged over many years. Only nine species were recognized when Hanken (1983a) published the first molecular data for the genus, and several of these had weak character support. Hanken showed that all nine species were diagnosable by allozymic character data and that there were an undetermined number of candidate species. Several of the original nine species and many of the candidate species occurred in sympatry, reinforcing the claim of additional, unnamed species. Many of these species were subsequently described in a series of papers (e.g. Hanken & Wake, 1994, 1998, 2001; Hanken *et al.*, 1999). All of the recently described taxa are diagnosable morphologically, and all those for which we have tissue samples are also diagnosable by molecular traits (allozyme and/or DNA sequence). Relatively few candidate species remain; formal descriptions of three of these are nearly completed (G. Parra-Olea, J. Hanken &

D. B. Wake, unpubl. data) and await only publication of the molecular phylogenetic analyses that we present here. Coalescent-based species delimitation methods (O'Meara, 2009; Yang & Rannala, 2010) would be a useful tool for identifying candidate species of *Thorius*, but these methods require multiple individuals per species and often cannot accommodate rare species known from only one or a few specimens (Lim, Balke & Meier, 2012). While *Thorius* were once common and many species are well represented in collections, most populations have declined in recent years (Parra-Olea, García-París & Wake, 1999; Rovito *et al.*, 2009) and many species have very few tissue samples available for sequencing.

COMPARATIVE ANALYSIS

In a non-adaptive radiation, closely related species are not expected to differ significantly in major morphological features (Gittenberger, 1991). While morphological character evolution could take place in such a scenario, we would expect variance in morphological characters between sympatric species to be no greater than that predicted by their phylogenetic distance, and morphological characters would be expected to exhibit significant phylogenetic signal. By contrast, if adaptive divergence in morphological characters takes place between species, traits should show little phylogenetic signal. Similarly, under a scenario of adaptive divergence, we would expect sympatric species, which have the potential to interact, to differ more than allopatric species after accounting for the effect of phylogenetic history. We tested both of these predictions – phylogenetic signal of morphological traits and morphological disparity between sympatric versus allopatric species – in *Thorius*. We then compared these results with patterns of body size evolution in *Batrachoseps*, which exemplifies cryptic species and non-adaptive radiation (Wake, 2006), and with previously published results for *Desmognathus*, which shows substantial divergence in body size and is considered an example of adaptive radiation in salamanders (Kozak *et al.*, 2005).

We constructed an ultrametric Bayesian consensus tree with mtDNA data for both *Thorius* and *Batrachoseps* using BEAST v.1.7.1, with a single sequence per species. For *Thorius*, data were partitioned in the same manner as in the MrBayes analyses and the same substitution models were used. For *Batrachoseps*, *cyt b* data from GenBank were partitioned by codon position and the following substitution models were used: codon position 1: SYM+G; codon position 2: HKY+I; codon position 3: GTR+G. The MCMC analysis was run for 10⁸ generations and sampled every 10 000 generations, with 2000 samples discarded as

burn-in. The relaxed molecular clock model was used for all partitions to account for possible rate variation among branches.

For *Thorius*, we tested phylogenetic signal of snout-vent length (SL), relative tail length (SL/TL), nostril shape (ND, ratio of nostril length to nostril width), and the presence or absence of maxillary teeth using the K statistic (Blomberg, Garland & Ives, 2003). K was calculated using the *Kcalc* function in the *picante* package (Kembel *et al.*, 2010) in the R environment for statistical computing (R Core Development Team, 2012); statistical significance of K was evaluated using the *phylosignal* function. We constructed species coexistence matrices for *Thorius* and *Batrachoseps*, as well as matrices of difference in maximum SL and cophenetic distance between species. We conducted a partial Mantel test (Smouse, Long & Sokal, 1986) using the *Mantel* function in the *ecodist* package (Goslee & Urban, 2007) in R to calculate the correlation between difference in maximum SL and species sympatry, while holding constant the effect of phylogenetic distance. We tested the significance of the correlation coefficient, *r*, using 9999 matrix permutations. Finally, we used ML trait reconstruction with an equal-rates model implemented in the package *GEIGER* (Harmon *et al.*, 2007) to reconstruct ancestral states for the presence of maxillary teeth on the phylogeny.

RESULTS

The species tree estimation from *BEAST contains three well-supported clades: (1) two species [posterior probability (PP) = 1.0] from northern portions of the range of the genus; (2) a group of seven species (PP = 0.99) that is more southern in distribution but overlaps the first clade at its southernmost extent; and (3) a group of 15 species (PP = 1.0) from the southern and more western parts of the range, including six candidate species (Figs 1, 2). The first clade includes the sister taxa *T. munificus* from north of Cofre de Perote and *T. lunaris* from south and east of Pico de Orizaba, both in Veracruz state. The second clade includes *T. spilogaster*, which is sympatric with *T. lunaris*; three sympatric species from the Puerto del Aire region – *T. dubitus*, *T. troglodytes*, and *T. magnipes* – which range south of the above two species; *T. schmidtii* and *T. maxillabrochus*, which are sympatric even further to the south, in south-eastern Puebla; and *T. pennatulus* from lowland Veracruz, mainly south and east of Pico de Orizaba. Based on allozyme comparisons (Hanken, 1983a) and the close morphological similarity of *T. pennatulus* and *T. narismagnus* (for which there are no DNA sequence data; Shannon & Werler, 1955; Hanken & Wake, 1998), we

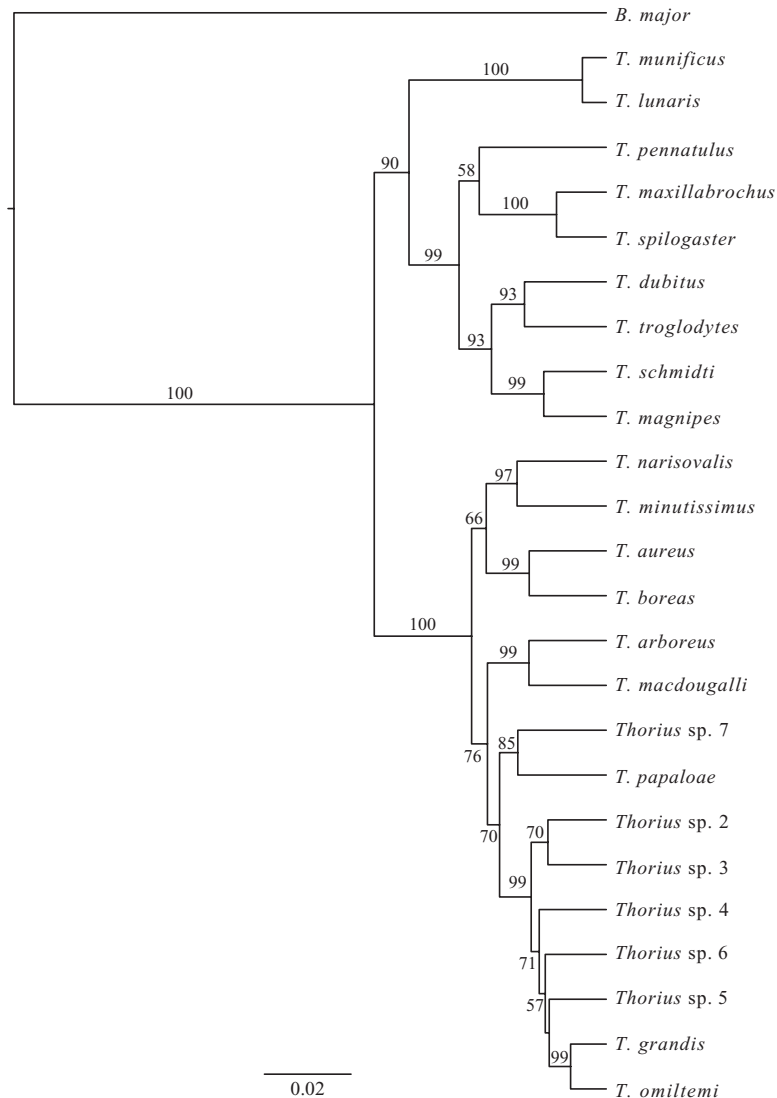

Figure 2. Species tree from *BEAST analysis of mtDNA and RAG1 data, with posterior probabilities of clades (multiplied by 100).

assign *T. narismagnus* to this clade as well. Hanken (1983a) found only one species in the Zoquitlán region of south-eastern Puebla, whereas we find two species, from different parts of the second clade, which correspond to a moderately sized, smaller nostriled *T. maxillabrochus* and a larger, smaller nostriled *T. schmidti*. The third clade contains named species from Guerrero and Oaxaca, as well as six candidate species (Figs 2, 3). The first two clades, from Puebla, Veracruz, and northern Oaxaca, are sister taxa (PP = 0.90).

The mtDNA gene tree displays the same general topology of the species tree, with three well-supported clades having an unresolved topology (Fig. 3). Each clade contains the same species as in the species tree. The first major clade includes *T. lunaris* and *T. mu-*

nificus [bootstrap support (BS) = 100, PP = 1.0]. In addition to the taxa in the species tree the second major clade (BS = 73, PP = 1.0) includes *T. adelos*, *T. insperatus*, *T. minydemus*, *T. smithi*, and one candidate species (*T. sp. 1*) for which only mtDNA was available. While the second clade is composed primarily of more northern species from the states of Puebla and Veracruz, three lowland species from northern Oaxaca are also included. *Thorius adelos*, which occurs in sympatry with both *T. insperatus* and *T. smithi*, is placed within this clade, but its relationships to the other species are not resolved, presumably because only a single, short fragment of 16S was sequenced for the species. The third major clade (BS = 76, PP = 1.0) contains species from the Sierra Madre del Sur of Guerrero and Oaxaca, the Mixteca region of

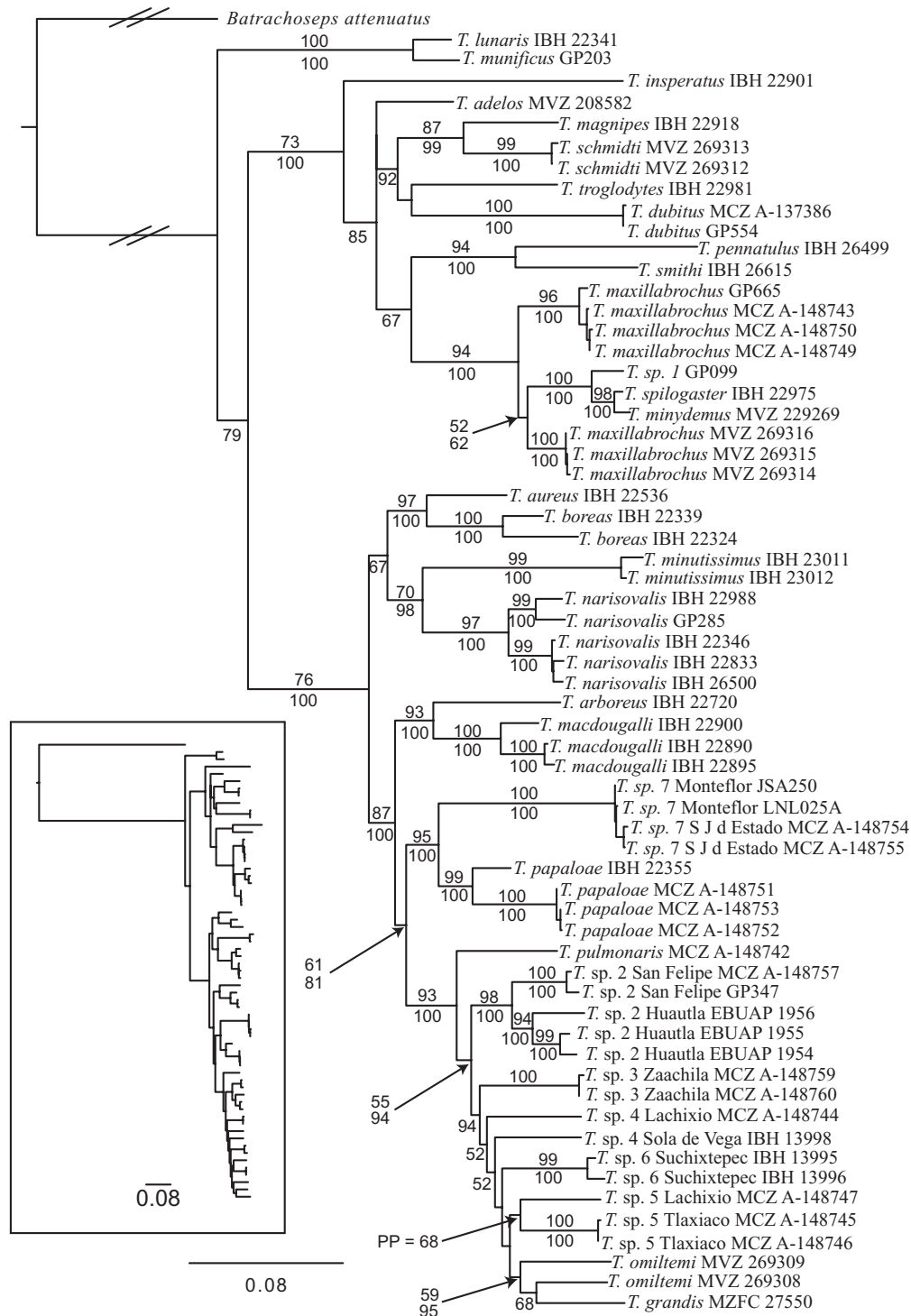

Figure 3. Phylogeny of *Thorius* from maximum-likelihood analysis of mtDNA. Bootstrap proportions are above branches; posterior probabilities from MrBayes analysis are below. The inset depicts divergence between outgroup and ingroup.

Oaxaca, and the remaining species from the Sierra de Juárez of Oaxaca. All species with multiple samples are supported as monophyletic with high support (BS > 70, PP > 0.95) except for *T. omiltemi*, which is para-

phyletic with respect to *T. grandis* with low support (BS = 51, PP = 0.69); *T. maxillabrochus*, which is paraphyletic (BS = 52, PP = 0.62); *T. sp. 4*, the two samples of which are part of an unresolved polytomy

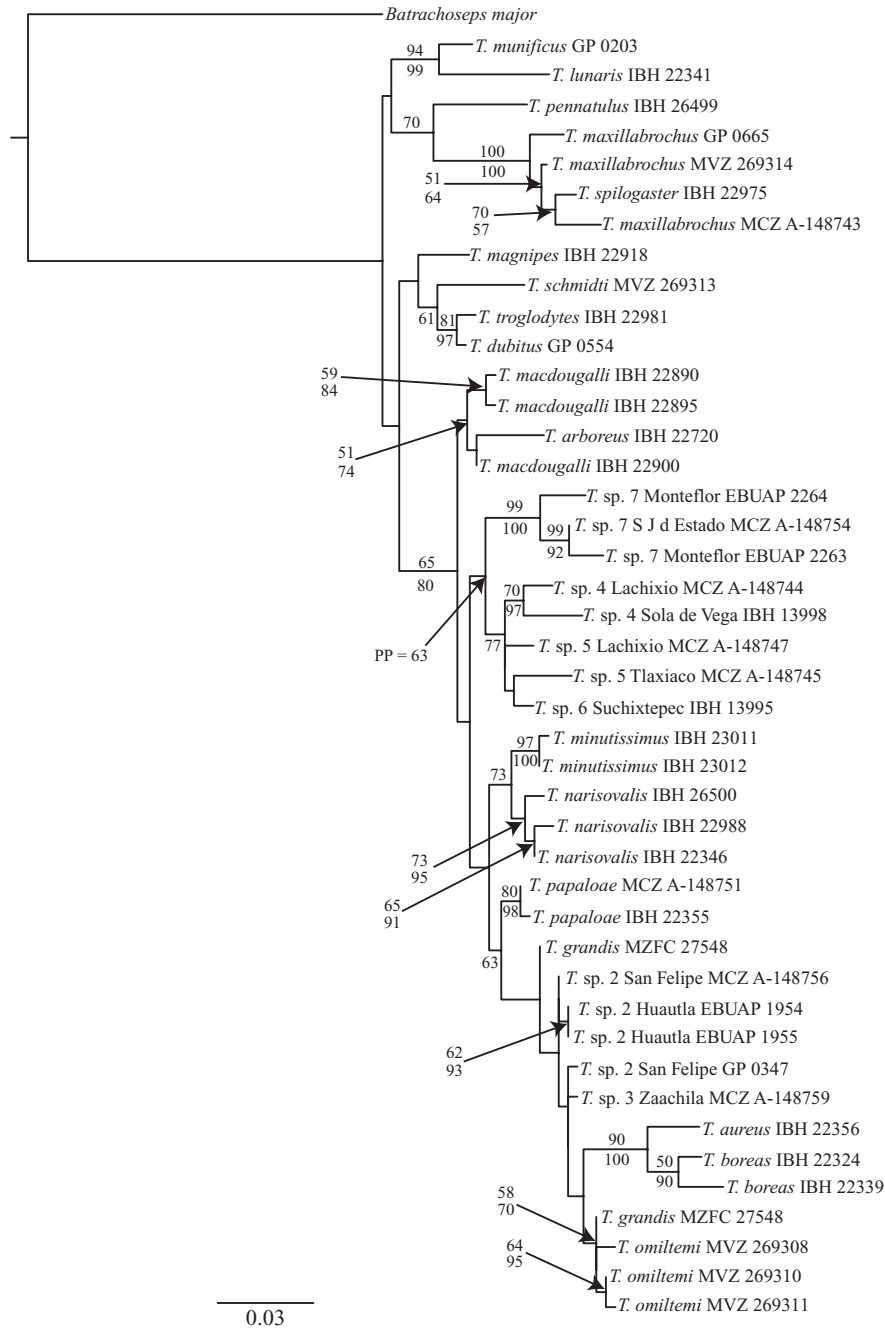

Figure 4. Phylogeny of *Thorius* from maximum-likelihood analysis of RAG1. Bootstrap proportions are above branches; posterior probabilities from MrBayes analysis are below.

(Fig. 3); and *T. sp. 5* (BS < 50, PP = 78). Many relationships within the third clade have low support or are unresolved. The mitochondrial gene tree in Figure S1 shows only those relationships with high support in both analyses (BS > 70, PP > 0.95), with less-well-supported nodes collapsed to polytomies.

Relationships in the RAG1 gene tree are generally less well supported than those in the mtDNA gene

tree (Fig. 4). Concordant with the mtDNA results, *T. lunaris* and *T. munificus* are strongly supported as sister species, as are *T. aureus* and *T. boreas*. *Thorius troglodytes* and *T. dubitus* are supported as sister taxa in the RAG1 tree, while their relationships to other taxa in the clade are unresolved in the mtDNA tree (Fig. S1). A small clade that includes a paraphyletic *T. maxillabrochus* and *T. spilogaster* is

supported (BS = 100, PP = 1), and *T. pennatulus* receives some support as the sister taxon of this clade (BS = 70). In contrast to the mtDNA gene tree, the monophyly of *T. sp. 4* is supported (BS = 70, PP = 97). *Thorius minutissimus* and *T. narisovalis* receive some support as sister taxa (BS = 73).

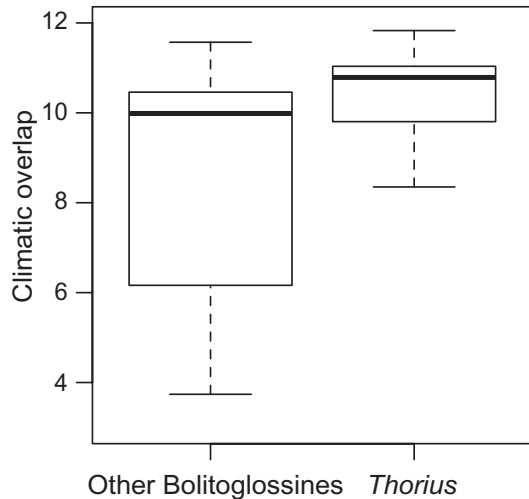

Figure 5. Boxplot of climatic overlap for sister species of *Thorius* compared with those for other genera of tropical bolitoglossine salamanders. Climatic overlap values range from 0 (no overlap) to 12 (complete overlap). Thick horizontal bar indicates median, boxes indicate interquartile range, and whiskers indicate range of data.

Climatic overlap between almost all sister species of *Thorius* (mean \pm SD, 10.4 ± 1.15) is higher than that between sister species of other genera of tropical bolitoglossines (8.8 ± 2.65 ; Fig. 5). Overlap is not significantly different, however, between sister species of *Thorius* and those of other tropical genera (Mann–Whitney test, $W = 41$, d.f. = 21, $P = 0.1794$), indicating that climatic niche divergence is not greater in *Thorius* than in other tropical salamanders.

Morphological data for named species of *Thorius*, derived from published descriptions and measurements, as well as for several candidate species currently being described, are given in Table S1. Comparisons of SL with SL/TL, LI, and nostril shape for named species are given in Tables 2–4. None of the morphological characters we tested for *Thorius* exhibits significant phylogenetic signal (SL: $K = 0.50$, $P = 0.21$; SL/TL: $K = 0.50$, $P = 0.29$; ND: $K = 0.46$, $P = 0.37$; LI: $K = 0.38$, $P = 0.60$; maxillary teeth: $K = 0.55$, $P = 0.22$). Species of *Thorius* exhibit significantly greater differences in SL when in sympatry than when in allopatry (Mantel $r = 0.10$, $P = 0.018$), whereas species of *Batrachoseps* do not (Mantel $r = 0.02$, $P = 0.38$).

DISCUSSION

Phylogenetic estimates can enhance our understanding of the forces that generate high tropical species diversity (Cardillo, Orme & Owens, 2005; Wiens, 2007; Kozak & Wiens, 2010; Cadena *et al.*, 2012).

Table 2. Comparison of mean nostril shape and mean body size (SL) in named species of *Thorius*

SL (mm)	Nostril shape (nostril length/width)			
	Round to slightly oval (< 1.2)	Oval (1.2–1.5)	Elliptical (1.5–1.7)	Elongated elliptical (1.7–2)
Very small (< 19)	<i>pennatulus</i> , <i>narismagnus</i>	<i>arboreus</i> , <i>insperatus</i> [3]		
Small (19–21)	<i>minydemus</i> (m, f) , <i>smithi</i> (m, f) [3]	<i>infernalis</i> , <i>dubitus</i> [1]		<i>papaloae</i> , <i>macdougalli</i> [2]
Moderate (21–25)	<i>adelos</i> (m, f) [3]	<i>munificus</i> , <i>magnipes</i> [1], <i>maxillabrochus</i> , <i>minutissimus</i> , <i>spilogaster</i> (m, f)	<i>trogodytes</i> [1]	<i>pulmonaris</i>
Large (25–27)		<i>grandis</i> (f) , <i>narisovalis</i>		<i>omiltemi</i> (f)
Very large (> 27)			<i>aureus</i> (m, f) [2], <i>lunaris</i> , <i>schmidtii</i> (m, f)	<i>boreas</i> [2]

Bold font denotes species with maxillary teeth; the sex possessing maxillary teeth is indicated in parentheses (m, male; f, female). Numbers in square brackets indicate sites with three sympatric species discussed in the text: [1] Puerto del Aire, Veracruz; [2] Cerro Pelón, Oaxaca; [3] Vista Hermosa, Oaxaca.

Table 3. Comparison of mean limb interval (number of costal grooves separating adpressed fore- and hind limbs) and mean body size (SL) in named species of *Thorius*; a small limb interval indicates long limbs relative to body size

SL (mm)	Relative limb length (mean limb interval)			
	Short (6–7)	Moderate (5–6)	Long (4–5)	Very long (< 4)
Very small (< 19)			<i>arboreus</i> , <i>narismagnus</i> , <i>pennatulus</i>	<i>insperatus</i> [3]
Small (19–21)		<i>infernalis</i>	<i>papaloeae</i> , <i>dubitus</i> [1]	<i>macdougalli</i> [2], <i>minydemus</i> , <i>smithi</i> [3]
Moderate (21–25)	<i>maxillabrochus</i> , <i>minutissimus</i>	<i>trogloodytes</i> [1]	<i>adelos</i> [3], <i>pulmonaris</i> , <i>spilogaster</i>	<i>magnipes</i> [1], <i>munificus</i>
Large (25–27)		<i>grandis</i> , <i>narisovalis</i> , <i>omiltemi</i>		
Very large (> 27)	<i>aureus</i> [2], <i>boreas</i> [2]	<i>lunaris</i> , <i>schmidti</i>		

Numbers in square brackets indicate sites with three sympatric species discussed in the text: [1] Puerto del Aire, Veracruz; [2] Cerro Pelón, Oaxaca; [3] Vista Hermosa, Oaxaca.

Table 4. Comparison of mean relative tail length (SL/TL) and mean body size (SL) in named species of *Thorius*

SL (mm)	Mean relative tail length (SL/TL)				
	Very long (< 0.8)	Long (0.8–0.9)	Moderately long (0.9–1.0)	Short (1.0–1.2)	Very short (> 1.2)
Very small (< 19)	<i>pennatulus</i> , <i>narismagnus</i>	<i>arboreus</i>	<i>insperatus</i> [3]		
Small (19–21)			<i>infernalis</i> , <i>smithi</i> [3]	<i>minydemus</i> , <i>macdougalli</i> [2]	<i>dubitus</i> [1]
Moderate (21–25)		<i>munificus</i> , <i>magnipes</i> [1], <i>trogloodytes</i> [1], <i>adelos</i> [3]		<i>minutissimus</i> , <i>spilogaster</i>	
Large (25–27)		<i>narisovalis</i>		<i>grandis</i> , <i>omiltemi</i>	
Very large (> 27)		<i>lunaris</i>	<i>aureus</i> [2]	<i>boreas</i> [2], <i>schmidti</i>	

Numbers in square brackets indicate sites with three sympatric species discussed in the text: [1] Puerto del Aire, Veracruz; [2] Cerro Pelón, Oaxaca; [3] Vista Hermosa, Oaxaca.

Hypotheses that emphasize the importance of factors controlling community assembly (Webb *et al.*, 2002; Kraft & Ackerly, 2010), climatic niche divergence among species (Kozak & Wiens, 2007, 2010), and broad-scale geographical patterns of clade distribution and diversification (Wiens *et al.*, 2006, 2007) all rely on a phylogenetic framework for the groups under study. Similarly, population-level phylogenies are useful for revealing previously unrecognized diversity (Molbo *et al.*, 2003; Foquet *et al.*, 2007), which is an essential step to understanding diversification of clades. Allozyme data for *Thorius* have been available for many years (Hanken, 1983a), but the addition of DNA sequence data for nearly all named species, as well as for many candidate species, offers a new and richer understanding of how these salamanders have diversified in a geographical

context. While all species of *Thorius* generally resemble one another in external morphology due to their small size, comparing lineages identified in our phylogeny has enabled us to perceive and document subtle morphological differences among species. When one takes into account the small size of *Thorius* in relation to other tropical salamanders, the species turn out to be morphologically distinct (Hanken & Wake, 1994, 1998, 2001; Hanken *et al.*, 1999). The DNA-based phylogeny enables us to place these morphological differences in both a biogeographical and a community context, advancing our understanding of how so many species have accumulated in a relatively small geographical region and of how multiple species can coexist at a single site.

Our phylogeny confirms that *Thorius* comprises many evolutionary lineages, some of which are

strongly divergent genetically (Tables S2–S5). Several species show substantial intraspecific genetic divergence as well. While some of these species, such as *T. narisovalis*, have geographical ranges that encompass multiple mountain ranges, others exhibit high interpopulational divergence within a single mountain range. For example, two samples of *T. boreas* separated by 17 km have a GTR distance of 0.05 for *cyt b* and 0.09 for ND4; Hanken (1983a) reported substantial interpopulational divergences in allozymes for this species. Using these phylogenetic results as a guide for morphological comparisons, we identify several unnamed candidate species (G. Parra-Olea, J. Hanken & D. B. Wake, unpubl. data; Fig. 3), largely concentrated in southern and western Oaxaca. Moreover, the short geographical distances that separate some of these divergent populations highlight the strong impact that miniaturization and its accompanying reduction of dispersal propensity and capability may have had on population divergence (Wollenberg *et al.*, 2011). Indeed, phylogenetic structure within *Thorius* seems almost fractal in nature (Wake, 2009), at least as an initial impression; while this complexity increases the challenge for delimiting species, it makes the group attractive for studying species formation and divergence in a geographical context. Beyond the question of the number of species, however, the high degree of morphological distinctiveness and frequent co-occurrence of related taxa suggest that, instead of a fractal pattern of differentiation, *Thorius* offers an example of an adaptive radiation in miniature.

GEOGRAPHICAL PATTERNS OF SPECIES DIVERSITY

The entire geographical range of *Thorius* is relatively small (Fig. 1). Including candidate species, 23 of the 31 species in the genus occur in the Trans-Mexican Volcanic Belt and the Oaxacan highlands of southern Mexico, extending from near Cofre de Perote, Veracruz, to the Sierra de Juárez, Oaxaca. Relative to the size of its geographical range, there are more species of *Thorius* than of any other genus of tropical salamanders. *Bolitoglossa* has 125 species (AmphibiaWeb, 2013), but it also has a much broader geographical range, which extends from Tamaulipas, Mexico, to Bolivia and Brazil. *Pseudoeurycea*, with 49 species, is also found in a substantially larger area, from northern Mexico to Guatemala. *Chiropterotriton*, with 12 described and numerous candidate species, is found in a larger area of Mexico, from Nuevo León to Oaxaca (Darda, 1994; Parra-Olea, 2003).

Phylogenetic analyses of DNA sequences reveal considerable phylogenetic and geographical structure within *Thorius*. Our analyses recover three well-differentiated major clades in both mitochondrial and

nuclear-gene topologies, and these clades are geographically based with limited sympatry between them. The first two clades occur in sympatry in Veracruz (*T. lunaris*, clade 1, and *T. spilogaster*, clade 2; Fig. 1A). Similarly, there is a single confirmed instance of sympatry between the second and third clades on the northern slopes of the Sierra de Juárez in northern Oaxaca (*T. adelos*, clade 2, and *T. arboreus*, clade 3; Fig. 1C); *T. insperatus* and *T. smithi* (both clade 2) are also found within 2 km of this site (Fig. 1B). Clades 1 and 3 are entirely allopatric.

Although our phylogenetic hypothesis includes three well-supported major clades, relationships within the two larger clades are not fully resolved. The tiny body size of all *Thorius* suggests that their dispersal distances are very short, as is true for most other plethodontid salamanders as well as other miniaturized animals (Wollenberg *et al.*, 2011). *Batrachoseps* in California disperse on average only a few metres (Hendrickson, 1954); as with *Thorius*, species of *Batrachoseps* typically display extreme range fragmentation and corresponding lineage divergence in allopatry (Jockusch & Wake, 2002). These facts, in light of the complex geological history of coastal California, led Wake (2006, 2009) to interpret diversification of *Batrachoseps* as an example of fractal diversification or non-adaptive radiation: a proliferation of morphologically similar species (most sister taxa are extremely difficult to separate) that also are similar in microhabitat and natural history. A similar combination of high susceptibility to range fragmentation and lack of gene flow among populations may be responsible for the large number of divergent lineages of *Thorius* within relatively small areas, including within species such as *T. boreas* and *T. maxillibrochus* (Fig. 3). This effect would be expected especially in areas such as the Trans-Mexican Volcanic Belt and the Oaxacan highlands, with their steep climatic gradients and rugged topography (Fig. 6). Small shifts in elevational ranges due to climatic or environmental change could isolate many populations across the landscape, leading to near-simultaneous divergence and poor resolution along many branches of the phylogeny. Unlike *Batrachoseps*, however, species proliferation in *Thorius* involves segregation in space and, in a few cases, in terrestrial versus arboreal microhabitat use, and these patterns of segregation are accompanied by morphological diversification. We conclude that *Thorius* has experienced an adaptive radiation in miniature – that is, in a geographically small but topographically complex landscape, and at a tiny body size.

Limited dispersal among populations of *Thorius* along climatic gradients could have led to parapatric or alloparapatric species formation (Endler, 1977;

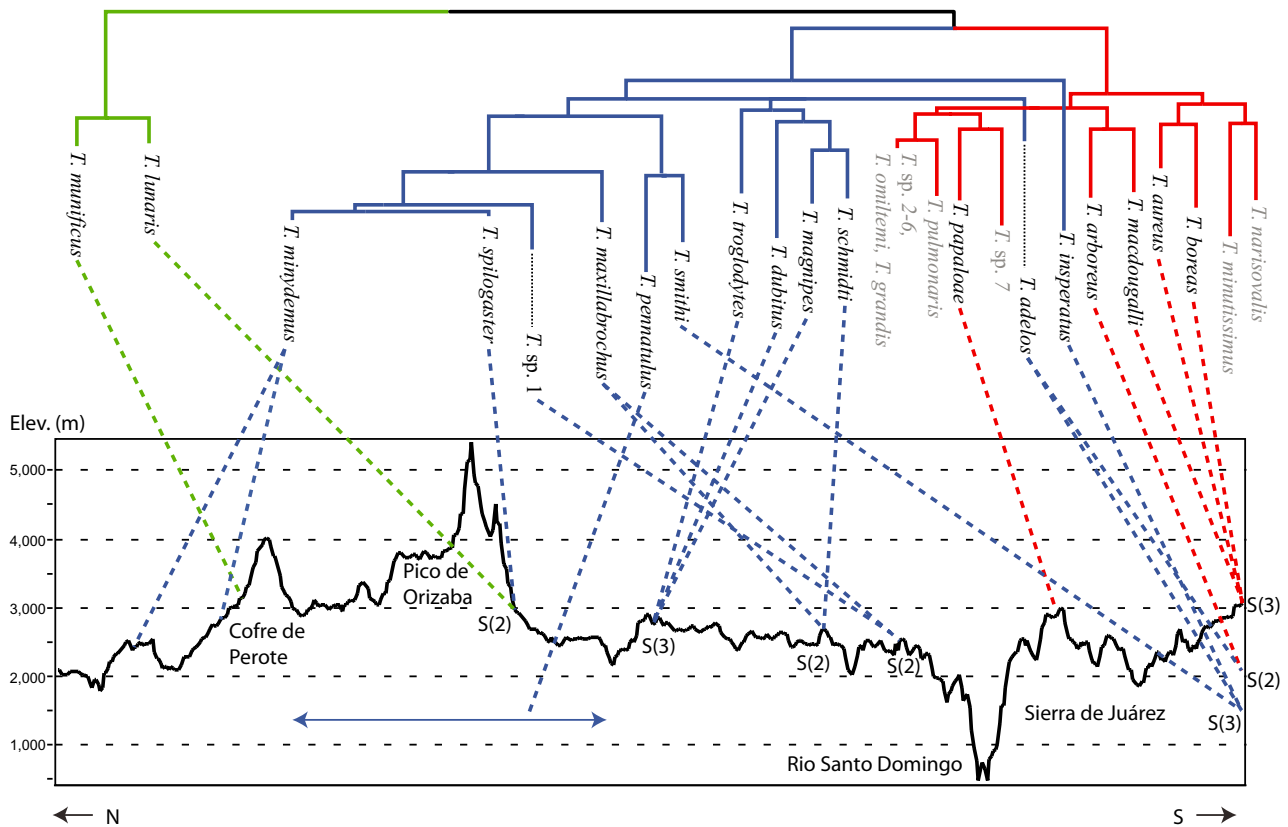

Figure 6. Elevational profile of the eastern Trans-Mexican Volcanic Belt and northern Oaxacan highlands, showing the distribution of species of *Thorius* – clade 1, green; clade 2, blue; and clade 3, red. Sites with two or three sympatric species are shown by S(2) and S(3), respectively. Species with names in grey font occur outside of the elevational profile.

Kozak & Wiens, 2007). Kozak & Wiens (2007, 2010) conclude that most speciation events in tropical salamanders involve climatic niche divergence, which suggests species formation along climatic gradients. In *Thorius*, however, only one sister-species pair is separated primarily by elevation, which is a strong proxy for climate (Fig. 6; see below). Furthermore, sister species of *Thorius* typically show very high climatic overlap, similar to levels of overlap between temperate plethodontids (Fig. 5; Kozak & Wiens, 2007). This suggests that divergence in temperature tolerance, as measured at a macroclimatic scale, is not an important component of species formation in *Thorius*. Instead, high climatic overlap supports a model of divergence in allopatry over one that involves divergence along elevational or climatic gradients.

Adams *et al.* (2009) found rates of morphological evolution to be uncorrelated with species diversification rate in neotropical salamanders. They further suggest that when climate is a primary mechanism

promoting species divergence, morphological change should not be expected unless it results from climate-related selection on morphology. In contrast, Rabosky & Adams (2012) show that morphological evolution and species diversification are correlated when analyses account for decreases in diversification rates over time. *Thorius* does not conform to a model of climatically driven divergence without associated morphological change: there is little climatic divergence between sister species (Fig. 5), and most closely related species differ in some morphological characters of presumed ecological relevance, such as presence or absence of maxillary teeth, body size, relative limb length, and relative tail length (Tables 2–4). Whereas some features may have a more or less fixed scaling relationship to body size, most variation in anatomical dimensions appears to be largely independent of body size. In other words, the small range of body size variation among the 24 named species cannot account for the vast majority of morphological differences among species.

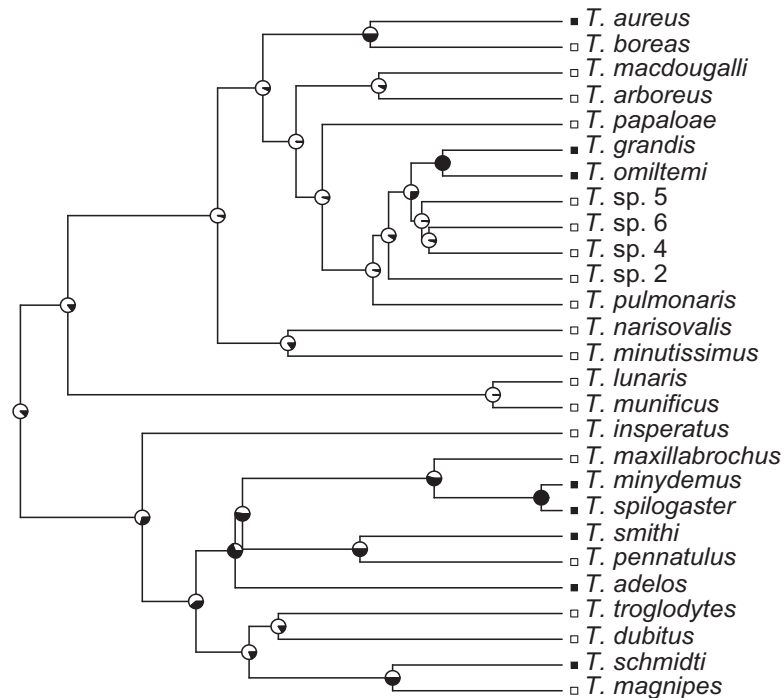

Figure 7. Maximum likelihood reconstruction of presence or absence of maxillary teeth among species of *Thorius*. Black squares at branch tips indicate species with maxillary teeth; white squares indicate those that lack maxillary teeth. Pies at nodes indicate the probability that ancestral species possessed maxillary teeth, based on an equal-rates model of discrete character change.

LOCAL AND REGIONAL SPECIES ASSEMBLAGES

Two or three species of *Thorius* were detected at 12 localities based on allozyme data (Hanken, 1983a). Our mtDNA data both confirm these earlier results and detect yet additional sympatric candidate species (*Thorius* spp. 1–3, 5; Figs 1, 3). By combining our phylogenetic results and morphological data, we can gain insight into the forces that may structure both local and regional assemblages of species. Three closely related species coexist at Puerto del Aire, Veracruz: *T. troglodytes*, *T. magnipes*, and *T. dubitus*. The first two species are moderately sized whereas the third is small; *T. dubitus* differs from the other two species in nostril shape; and all three species differ in relative limb length (Tables 2, 3; Fig. 8; Hanken & Wake, 1998, fig. 13). Additionally, *T. magnipes* is arboreal, occupying bromeliads, while the other two species are exclusively terrestrial (*T. dubitus*, in pine litter) or terrestrial and transitional (*T. troglodytes*, in leaf litter, under cover objects, or under the bark of fallen branches). At Xometla, Veracruz, *T. lunaris* differs from *T. spilogaster* in dentition, body size, nostril shape, relative limb length, and relative tail length, but no differences in microhabitat use have been detected (Fig. 1; Tables 2, 4).

The highest known species diversity of *Thorius* occurs on an elevational transect that extends across Cerro Pelón, Oaxaca: seven species are encountered over a distance of 18 km (Hanken, 1983a; Hanken & Wake, 1994). Three species are found in microsympatry near the summit (c. 3000 m elevation), *T. aureus*, *T. boreas*, and *T. macdougalli* (Figs 2, 7). Although all three species appear to occupy identical terrestrial microhabitats, there are conspicuous differences in morphology. *Thorius macdougalli* differs from the other two species by its small body size and larger limb interval (Table 3; Fig. 8). *Thorius aureus* and *T. boreas* are both larger, more robust species, but *T. aureus* has many maxillary teeth while *T. boreas* lacks them, as do most *Thorius* (Table 2). *Thorius boreas* also has a relatively longer tail than *T. aureus* (Table 4). At lower elevations on the same transect (c. 2400 m), *T. aureus* is found sympatrically instead with *T. arboreus*, a much smaller, toothless, longer-limbed and arboreal species (Tables 2, 3; Hanken & Wake, 1994). Slightly lower, at c. 2000 m elevation, *T. arboreus* is sympatric with *T. adelos*; while both species are arboreal, *T. adelos* is larger and has a more fully developed and robust skull with many well-developed maxillary teeth (Wake *et al.*, 2012). The range of *T. adelos* extends to still lower elevations in the cloud forest (c. 1500 m), where it is sympatric

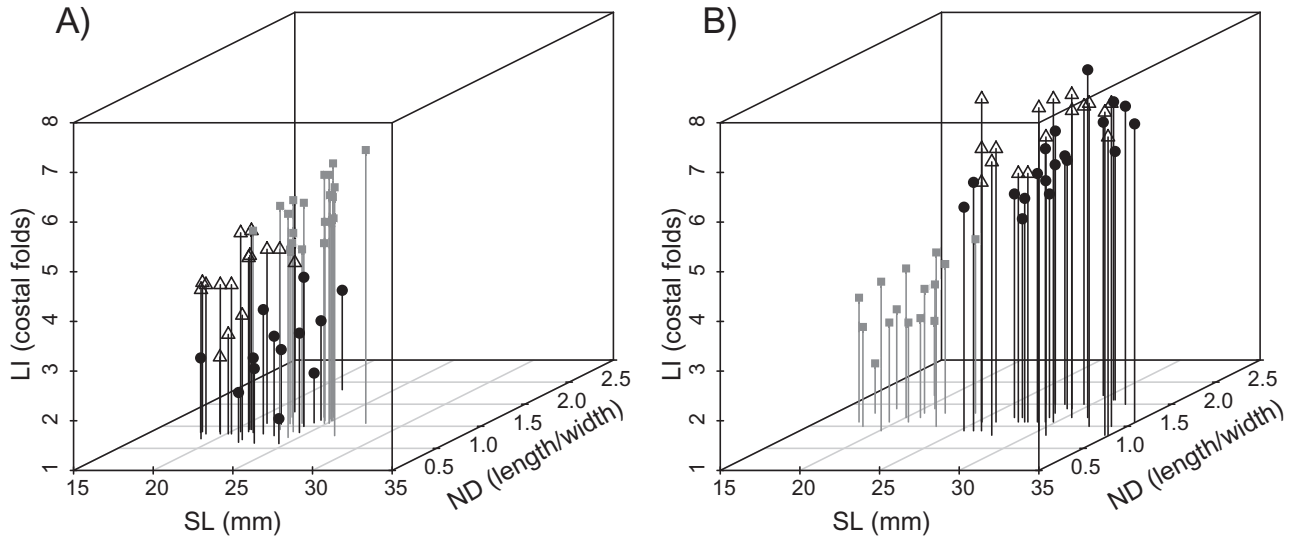

Figure 8. Three-dimensional plots of snout–vent length (SL), limb interval (LI), and nostril shape (ratio of nostril dimensions, ND) for sympatric species of *Thorius*. A, Puerto del Aire, Veracruz. Black circles, *T. magnipes*; grey squares, *T. troglodytes*; and white triangles, *T. dubitus*. B, Cerro Pelón, Oaxaca. Black circles, *T. boreas*; grey squares, *T. macdougalli*; and white triangles, *T. aureus*.

with two additional species: *T. insperatus* and *T. smithi* (Papenfuss & Wake, 1987; Hanken & Wake, 1994). The latter two species are both small, but *T. smithi* has many maxillary teeth and round nostrils whereas *T. insperatus* is toothless with oval nostrils (Table 2). *Thorius adelos* has many maxillary teeth, but it is larger and has a longer tail than both *T. smithi* and *T. insperatus* (Tables 2, 4) and its skull is far more robust (Wake *et al.*, 2012). Microhabitat partitioning among species, as described above for Puerto del Aire, also occurs at this site: *T. smithi* is exclusively terrestrial, *T. adelos* is exclusively arboreal (in bromeliads), and *T. insperatus* occupies both microhabitats.

Sympatric species of *Thorius* tend to differ first by body size and secondly by the presence or absence of maxillary teeth. At several sites (e.g. Puerto del Aire, Cerro Pelón), sympatric species are close relatives. Microhabitat partitioning also appears to be important at two sites, but it is of limited utility in explaining divergence or coexistence for most species in the genus because only four species are known to occupy non-terrestrial habitats. Most sympatric species of *Thorius* can be found in microsymbatry under cover objects. It is possible that the morphological differences outlined above, and especially body size and dentition, allow these species to occupy different trophic niches, for example by partitioning the arthropod prey base by size (Lynch, 1985). In combination with the low dispersal capability of these salamanders, niche partitioning related to diet, habitat, or other factors may have contributed to the accumula-

tion of a large number of species of *Thorius* in a relatively small geographical area. Range fragmentation probably promotes divergence of sister species in allopatry, possibly accompanied by morphological divergence. Sympatric species of *Thorius*, including sister-species pairs such as *T. aureus*/*T. boreas* and *T. troglodytes*/*T. dubitus*, might have diverged morphologically during allopatric speciation or following secondary contact. They even may have arisen via divergent selection in sympatry, parapatry, or alloparapatry.

Unlike *Batrachoseps*, which has diversified primarily due to range fragmentation without substantial morphological divergence (Wake, 2006), results of the partial Mantel test show that sympatric species of *Thorius* differ more in body size than those found in allopatry, after accounting for the effect of phylogenetic history. Even *Desmognathus*, which has been proposed as an example of adaptive radiation in salamanders, does not show this pattern (Kozak *et al.*, 2005). Greater divergence in body size in sympatry and the lack of significant phylogenetic signal in morphological traits such as limb length, relative tail length, and presence of maxillary teeth support our hypothesis that species of *Thorius* have evolved through a process of adaptive morphological divergence.

Miniaturization in *Thorius* is achieved mechanistically through a novel pattern of determinate growth that is associated with precocious sexual maturation and hyperossification of the skeleton (Hanken, 1982), yet functional constraints on the minimum size of the

brain and visual system impose a minimum body size on these salamanders (Roth *et al.*, 1990). While species of *Thorius* attain different adult body sizes through differences in the timing of ossification, the overall range of body size within the genus is small (15.4 mm range of maximum SL; Table 2, Table S1). These constraints on both absolute size and variation in size have doubtless contributed to taxonomic confusion and underestimation of species diversity within the genus, along with the frequent failure to perceive the relatively large differences among species in multiple morphological characters (Tables 2–4). Miniaturization has enabled *Thorius* to occupy physical niches that are inaccessible to larger plethodontid salamanders and to behave in novel ways enabled by their small size, such as behavioural thermoregulation within confined moist microenvironments (Feder, 1982). At the same time, the developmental and functional constraints on body size in the genus prevent them from occupying some ecological niches filled by larger tropical salamanders. To achieve ecomorphological differentiation, species of *Thorius* seem to have diverged primarily along a limited set of morphological axes that are less constrained than body size, namely relative limb and tail length, dentition, and nostril size and shape. Consequently, despite high regional diversity, no more than three species of *Thorius* coexist at any one site and sympatric species always differ in at least one, and typically several, of these morphological features. In *Thorius*, constraints imposed by developmental patterns that limit body size may open new niches while simultaneously limiting the total number of species that can exist at any one site. Although the concept of key innovation has proven difficult to demonstrate (Losos, 2010), we believe that miniaturization, with its manifest impact on the whole organism and its functioning (e.g. Roth *et al.*, 1990), may well qualify for that term. At a minimum, it is a foundational phenomenon that has impacted the entire evolutionary history of *Thorius*.

Few salamander genera vary so markedly in features such as dentition and degree of skull ossification as does *Thorius*. An especially interesting feature of the evolution of *Thorius* is the phylogenetic distribution of traits that we envisage as ancestral, such as maxillary teeth. Lack of maxillary dentition was long regarded as characteristic of all *Thorius* (Taylor, 1944), but Gehlbach (1959) reported these teeth in two new species he described, *T. maxillabrochus* and *T. schmidtii*. Maxillary teeth were subsequently observed in other new species (Table 2). An ML reconstruction of presence or absence of maxillary teeth reveals substantial homoplasy with respect to maxillary dentition (Fig. 7). Although lack of maxillary teeth is the most likely ancestral condition, we cannot

exclude the possibility that the common ancestor of all extant species had them. What seems more likely is that maxillary teeth have been gained and lost repeatedly during the radiation of the clade as a whole.

Species of *Thorius* are not simply scaled-up or scaled-down versions of each other (Tables 2–4). Rather, with respect to features such as teeth, limbs, nostril size, and tail length, species formation has involved diversification in traits that are likely to play important roles in adaptation and community organization. The evolutionary history of *Thorius* is one of ecomorphological divergence, which is typically associated with adaptive radiation.

ACKNOWLEDGEMENTS

We thank M. García-París, I. Caviedes-Solis, and P. Tenorio for help in the field; L. Canseco, O. Flores-Villela, and J. Campbell for providing tissues; and J. Streicher for providing measurements for *T. adelos*. Technical assistance and support were contributed by L. Márquez (Laboratorio de Biología Molecular, I-Biología, UNAM). D. Buckley and three anonymous reviewers provided comments that greatly improved the manuscript. Research was supported by PAPIIT-UNAM IN212111 to G.P.-O.; the U.S. National Science Foundation (EF-0334846 to J.H., EF-0334939 to D.B.W. and DEB-0613802 to J. A. Campbell); the Council on Research and Creative Work, University of Colorado at Boulder; the Museum of Vertebrate Zoology, the Center for Latin American Studies, and Sigma Xi (Alpha chapter), University of California at Berkeley; and the Putnam Expeditionary Fund of the Museum of Comparative Zoology and the David Rockefeller Center for Latin American Studies, Harvard University. S.M.R. was funded by a UC-MEXUS CONACyT postdoctoral fellowship and an NSF Bioinventory Grant (DEB 1026396). We thank the Comisariados de Bienes Comunales of Santiago Comaltepec and San Pedro Yolox for permission to work in their communities and for their hospitality and friendship during our visits. Collecting permits were provided by the Secretaria del Medio Ambiente y Recursos Naturales (SEMARNAT) to G.P.-O.

REFERENCES

- Adams DC, Berns CM, Kozak KH, Wiens JJ. 2009. Are rates of species diversification correlated with rates of morphological evolution? *Proceedings of the Royal Society B* **276**: 2729–2738.
- AmphibiaWeb. 2013. *Information on amphibian biology and conservation [web application]*. Berkeley, CA: AmphibiaWeb. Available at: <http://amphibiaweb.org> (accessed 9 April 2013).

- Arévalo E, Davis SK, Sites JW. 1994.** Mitochondrial DNA sequence divergence and phylogenetic relationships among eight chromosome races of the *Sceloporus grammicus* complex (Phrynosomatidae) in central Mexico. *Systematic Biology* **43**: 387–418.
- Bickford D, Lohman DJ, Sodhi NS, Ng PKL, Meier R, Winker K, Ingram KK, Das I. 2006.** Cryptic species as a window on diversity and conservation. *Trends in Ecology and Evolution* **22**: 148–155.
- Blomberg SP, Garland T Jr, Ives AR. 2003.** Testing for phylogenetic signal in comparative data: behavioral traits are more labile. *Evolution* **57**: 717–745.
- Brandley MC, Schmitz A, Reeder TW. 2005.** Partitioned Bayesian analysis, partition choice, and the phylogenetic relationships of scincid lizards. *Systematic Biology* **54**: 373–390.
- Cadena CD, Kozak KH, Gómez JP, Parra JL, McCain CM, Bowie RCK, Carnaval AC, Moritz C, Rahbek C, Roberts TE, Sanders NJ, Schneider CJ, VanDerWal J, Zamudio KR, Graham CA. 2012.** Latitude, elevational climatic zonation and speciation in New World vertebrates. *Proceedings of the Royal Society B* **279**: 194–201.
- Cardillo M, Orme CDL, Owens IPF. 2005.** Testing for latitudinal bias in diversification rates: an example using New World birds. *Ecology* **86**: 2278–2287.
- Cope ED. 1869.** A review of the species of the Plethodontidae and Desmognathidae. *Proceedings of the Academy of Natural Sciences of Philadelphia* **21**: 93–118.
- Cope ED. 1889.** The batrachia of North America. *Bulletin of the United States National Museum* **34**: 1–525.
- Darda DM. 1994.** Allozyme variation and morphological evolution among Mexican salamanders of the genus *Chiropetrotriton* (Caudata: Plethodontidae). *Herpetologica* **50**: 164–187.
- Degnan JH, Rosenberg NA. 2006.** Discordance of species trees with their most likely gene trees. *PLoS Genetics* **2**: 762–768.
- Drummond AJ, Rambaut A. 2007.** BEAST: Bayesian evolutionary analysis by sampling trees. *BMC Evolutionary Biology* **7**: 214.
- Dunn ER. 1926.** *The salamanders of the family Plethodontidae*. Northampton, MA: Smith College.
- Edgar RC. 2004.** MUSCLE: a multiple sequence alignment method with reduced time and space complexity. *BMC Bioinformatics* **5**: 1–19.
- Edwards SV, Liu L, Pearl DK. 2007.** High resolution species trees without concatenation. *Proceedings of the National Academy of Sciences of the United States of America* **104**: 5936–5941.
- Elmer KR, Bonett RM, Wake DB, Lougheed SC. 2013.** Early Miocene origin and cryptic diversification of South American salamanders. *BMC Evolutionary Biology* **13**: 59.
- Endler J. 1977.** *Geographic variation, speciation, and clines*. Princeton, NJ: Princeton University Press.
- Feder ME. 1982.** Thermal ecology of neotropical lungless salamanders (Amphibia: Plethodontidae): environmental temperatures and behavioral responses. *Ecology* **63**: 1665–1674.
- Foquet A, Gilles A, Vences M, Marty C, Blanc M, Gemmell NJ. 2007.** Underestimation of species richness in neotropical frogs revealed by mtDNA analyses. *PLoS One* **10**: e1109.
- García-París M, Wake DB. 2000.** Molecular phylogenetic analysis of relationships of the tropical salamander genera *Oedipina* and *Nototriton*, with descriptions of a new genus and three new species. *Copeia* **2000**: 42–70.
- Gehlbach FH. 1959.** New plethodontid salamanders of the genus *Thorius* from Puebla, Mexico. *Copeia* **1959**: 203–206.
- Ghalambor CK, Huey RB, Martin PR, Tewksbury JJ, Wang G. 2006.** Are mountain passes higher in the tropics? Janzen's hypothesis revisited. *Integrative and Comparative Biology* **46**: 5–17.
- Gittenberger E. 1991.** What about non-adaptive radiation? *Biological Journal of the Linnean Society* **43**: 263–272.
- Goslee SC, Urban DL. 2007.** The ecodist package for dissimilarity-based analysis of ecological data. *Journal of Statistical Software* **22**: 1–19.
- Hall CW. 1952.** Comparative osteology of salamanders of the genus *Thorius*. M.A. Thesis, University of Kansas.
- Hanken J. 1982.** Appendicular skeletal morphology in minute salamanders, genus *Thorius* (Amphibia: Plethodontidae): growth regulation, adult size determination, and natural variation. *Journal of Morphology* **17**: 57–77.
- Hanken J. 1983a.** Genetic variation in a dwarfed lineage, the Mexican salamander genus *Thorius* (Amphibia: Plethodontidae): taxonomic, ecologic, and evolutionary implications. *Copeia* **1983**: 1051–1073.
- Hanken J. 1983b.** Miniaturization and its effects on cranial morphology in plethodontid salamanders, genus *Thorius* (Amphibia: Plethodontidae): II. The fate of the brain and sense organs and their role in skull morphogenesis and evolution. *Journal of Morphology* **177**: 255–268.
- Hanken J. 1984.** Miniaturization and its effects on cranial morphology in plethodontid salamanders, genus *Thorius* (Amphibia: Plethodontidae). I. Osteological variation. *Biological Journal of the Linnean Society* **23**: 55–75.
- Hanken J. 1985.** Morphological novelty in the limb skeleton accompanies miniaturization in salamanders. *Science* **229**: 871–874.
- Hanken J, Wake DB. 1993.** Miniaturization of body size: organismal consequences and evolutionary significance. *Annual Review of Ecology and Systematics* **24**: 501–519.
- Hanken J, Wake DB. 1994.** Five new species of minute salamanders, genus *Thorius* (Caudata: Plethodontidae), from northern Oaxaca, Mexico. *Copeia* **1994**: 573–590.
- Hanken J, Wake DB. 1998.** Biology of tiny animals: systematics of the minute salamanders (*Thorius*: Plethodontidae) from Veracruz and Puebla, Mexico, with descriptions of five new species. *Copeia* **1998**: 312–345.
- Hanken J, Wake DB. 2001.** A seventh species of minute salamander (*Thorius*: Plethodontidae) from the Sierra de Juárez, Oaxaca, Mexico. *Herpetologica* **57**: 515–523.
- Hanken J, Wake DB, Freeman HL. 1999.** Three new species of minute salamanders (*Thorius*: Plethodontidae) from Guerrero, Mexico, including the report of a novel dental polymorphism in urodeles. *Copeia* **1999**: 917–931.

- Harmon LJ, Weir JT, Brock CD, Glor RE, Challenger W. 2007.** GEIGER: investigating evolutionary radiations. *Bioinformatics* **24**: 129–131.
- Heled J, Drummond AJ. 2010.** Bayesian inference of species trees from multilocus data. *Molecular Biology and Evolution* **27**: 570–580.
- Hendrickson JR. 1954.** Ecology and systematics of salamanders of the genus *Batrachoseps*. *University of California Publications in Zoology* **54**: 1–46.
- Hijmans RJ, Cameron SE, Parra JL, Jones PG, Jarvis A. 2005.** Very high resolution interpolated climate surfaces for global land areas. *International Journal of Climatology* **25**: 1965–1978.
- Huelsenbeck JP, Ronquist F. 2001.** MrBayes: Bayesian inference of phylogenetic trees. *Bioinformatics* **17**: 754–755.
- Janzen DH. 1967.** Why mountain passes are higher in the tropics. *The American Naturalist* **101**: 233–249.
- Jockusch EL, Wake DB. 2002.** Falling apart and merging: diversification of slender salamanders (Plethodontidae: *Batrachoseps*) in the American West. *Biological Journal of the Linnean Society* **76**: 361–391.
- Kembel SW, Cowan PD, Helmus MR, Cornwell WK, Morlon H, Ackerly DD, Blomberg SP, Webb CO. 2010.** Picante: R tools for integrating phylogenies and ecology. *Bioinformatics* **26**: 1463–1464.
- Kozak KH, Larson A, Bonett RM, Harmon LJ. 2005.** Phylogenetic analysis of ecomorphological divergence, community structure, and diversification rates in dusky salamanders (Plethodontidae: *Desmognathus*). *Evolution* **59**: 2000–2016.
- Kozak KH, Weisrock DW, Larson A. 2006.** Rapid lineage accumulation in a non-adaptive radiation: phylogenetic analyses of diversification rates in eastern North American woodland salamanders (Plethodontidae: *Plethodon*). *Proceedings of the Royal Society B* **273**: 539–546.
- Kozak KH, Wiens JJ. 2007.** Climatic zonation drives latitudinal variation in speciation mechanisms. *Proceedings of the Royal Society B* **274**: 2995–3003.
- Kozak KH, Wiens JJ. 2010.** Accelerated rates of climatic niche evolution underlie rapid species diversification. *Ecology Letters* **13**: 1378–1389.
- Kraft NJB, Ackerly DD. 2010.** Functional trait and phylogenetic tests of community assembly across spatial scales in an Amazonian forest. *Ecological Monographs* **80**: 401–422.
- Lim GS, Balke M, Meier R. 2012.** Determining species boundaries in a world full of rarity: singletons, species delimitations methods. *Systematic Biology* **61**: 165–169.
- Losos JB. 2010.** Adaptive radiation, ecological opportunity and evolutionary determinism. *The American Naturalist* **175**: 623–639.
- Lynch JF. 1985.** The feeding ecology of *Aneides flavipunctatus* and sympatric plethodontid salamanders in northwestern California. *Journal of Herpetology* **19**: 328–352.
- Molbo D, Machado CA, Sevenster JG, Keller K, Herre EA. 2003.** Cryptic species of fig-pollinating wasps: implications for the evolution of the fig-wasp mutualism, sex allocation, and precision of adaptation. *Proceedings of the National Academy of Sciences of the United States of America* **100**: 5867–5872.
- Moritz C, Schneider CJ, Wake DB. 1992.** Evolutionary relationships within the *Ensatina eschscholtzii* complex confirm the ring species interpretation. *Systematic Biology* **41**: 273–291.
- Nylander JAA. 2004.** *MrModeltest Version 2. Program distributed by the author.* Uppsala University, Sweden: Evolutionary Biology Centre.
- Nylander JAA, Wilgenbusch JC, Warren DL, Swofford DL. 2008.** AWTY (Are We There Yet?): a system for graphical exploration of MCMC convergence in Bayesian phylogenetics. *Bioinformatics* **24**: 581–583.
- O'Meara B. 2009.** New heuristic methods for joint species delimitation and species tree inference. *Systematic Biology* **59**: 59–73.
- Padial JM, Miralles A, De la Riva I, Vences M. 2010.** The integrative future of taxonomy. *Frontiers in Zoology* **7**: 16.
- Palumbi SR, Martin AP, Romano S, McMillan WO, Stice L, Grabowski G. 1991.** *The simple fool's guide to PCR.* Honolulu, HI: University of Hawaii.
- Pamilo P, Nei M. 1988.** Relationships between gene trees and species trees. *Molecular Biology and Evolution* **5**: 568–583.
- Papenfuss TJ, Wake DB. 1987.** Two new species of plethodontid salamanders (genus *Nototriton*) from Mexico. *Acta Zoologica Mexicana* **21**: 1–16.
- Parra-Olea G. 2003.** Phylogenetic relationships of the genus *Chiropterotriton* (Caudata: Plethodontidae) based on 16S ribosomal DNA. *Canadian Journal of Zoology* **81**: 2048–2060.
- Parra-Olea G, García-París M, Wake DB. 1999.** Status of some populations of Mexican salamanders (Amphibia: Plethodontidae). *Revista de Biología Tropical* **47**: 217–223.
- Pond SLK, Frost SDW. 2005.** Datamonkey: rapid detection of selective pressure on individual sites of codon alignments. *Bioinformatics* **21**: 2531–2533.
- Pond SLK, Frost SDW, Muse SV. 2005.** HyPhy: hypothesis testing using phylogenies. *Bioinformatics* **21**: 676–679.
- Pond SLK, Posada D, Gravenor MB, Woelk CH, Frost SDW. 2006.** Automated phylogenetic detection of recombination using a genetic algorithm. *Molecular Biology and Evolution* **23**: 1891–1901.
- Pyron RA, Wiens JJ. 2011.** A large-scale phylogeny of Amphibia including over 2800 species, and a revised classification of extant frogs, salamanders, and caecilians. *Molecular Phylogenetics and Evolution* **61**: 543–583.
- de Quieroz K. 1998.** The general lineage concept of species, species criteria, and the process of speciation. In: Howard DJ, Berlocher SH, eds. *Endless forms: species and speciation.* New York: Oxford University Press, 57–75.
- R Core Development Team. 2012.** *R: a language and environment for statistical computing.* Vienna, Austria: R Foundation for Statistical Computing.
- Rabosky DL, Adams DC. 2012.** Rates of morphological evolution are correlated with species richness in salamanders. *Evolution* **66**: 1807–1818.

- Rambaut A, Drummond AJ. 2007.** Tracer v1.5. Available at: <http://beast.bio.ed.ac.uk/Tracer>
- Rosenberg NA, Nordborg M. 2002.** Genealogical trees, coalescent theory and the analysis of genetic polymorphisms. *Nature Reviews Genetics* **3**: 380–390.
- Roth G, Rottluff B, Grunwald W, Hanken J, Linke R. 1990.** Miniaturization in plethodontid salamanders (Caudata: Plethodontidae) and its consequences for the brain and visual system. *Biological Journal of the Linnean Society* **40**: 165–190.
- Rovito SM, Parra-Olea G, Vásquez-Almazán CR, Papenfuss TJ, Wake DB. 2009.** Dramatic declines in neotropical salamander populations are an important part of the global amphibian crisis. *Proceedings of the National Academy of Sciences of the United States of America* **106**: 3231–3236.
- Ruber L, Kottelat M, Tan HH, Ng PKL, Britz R. 2007.** Evolution of miniaturization and the phylogenetic position of *Paedocypris*, comprising the world's smallest vertebrate. *BMC Evolutionary Biology* **7**: 38.
- San Mauro D, Gower DJ, Oommen OV, Wilkinson M, Zardoya R. 2004.** Phylogeny of caecilian amphibians (Gymnophiona) based on complete mitochondrial genomes and nuclear RAG1. *Molecular Phylogenetics and Evolution* **33**: 413–427.
- Schmidt A, Wake MH. 1997.** Cellular migration and morphological complexity in the caecilian brain. *Journal of Morphology* **231**: 11–28.
- Shannon FA, Werler JE. 1955.** Notes on amphibians of the Los Tuxtlas Range of Veracruz, Mexico. *Transactions of the Kansas Academy of Sciences* **58**: 360–386.
- Smouse PE, Long JC, Sokal RR. 1986.** Multiple regression and correlation extensions of the Mantel test of matrix correspondence. *Systematic Zoology* **35**: 627–632.
- Stamatakis A. 2006.** RAxML-VI-HPC: maximum likelihood-based phylogenetic analyses with thousands of taxa and mixed models. *Bioinformatics* **22**: 2688–2690.
- Stephens M, Smith NJ, Donnelly P. 2001.** A new statistical method for haplotype reconstruction from population data. *American Journal of Human Genetics* **68**: 978–989.
- Taylor EH. 1941.** Herpetological miscellany, No. II. *University of Kansas Science Bulletin* **27**: 105–138.
- Taylor EH. 1944.** The genera of plethodont salamanders in Mexico, Pt. I. *University of Kansas Science Bulletin* **30**: 189–232.
- Vences M, Wake DB. 2007.** Speciation, species boundaries and phylogeography of amphibians. *Amphibian Biology* **7**: 2614–2671.
- Vieites DR, Min M, Wake DB. 2007.** Rapid diversification and dispersal during periods of global warming by plethodontid salamanders. *Proceedings of the National Academy of Sciences of the United States of America* **104**: 19903–19907.
- Vieites DR, Nieto Román S, Wake MH, Wake DB. 2011.** A multigenic perspective on the relationships in the largest family of salamanders, the Plethodontidae. *Molecular Phylogenetics and Evolution* **59**: 623–635.
- Wake DB. 2006.** Problems with species: patterns and processes of species formation in salamanders. *Annals of the Missouri Botanical Garden* **93**: 8–23.
- Wake DB. 2009.** What salamanders have taught us about evolution. *Annual Review of Ecology, Evolution and Systematics* **40**: 333–352.
- Wake DB. 2012.** Taxonomy of salamanders of the family Plethodontidae (Amphibia: Caudata). *Zootaxa* **3484**: 75–82.
- Wake DB, Rovito SM, Maisano JA, Hanken J. 2012.** Taxonomic status of the enigmatic salamander *Cryptotriton adelos* (Amphibia: Plethodontidae) from northern Oaxaca, Mexico, with observations on its skull and postcranial skeleton. *Zootaxa* **3579**: 67–70.
- Webb CO, Ackerly DD, McPeck M, Donoghue MJ. 2002.** Phylogenies and community ecology. *Annual Review of Ecology and Systematics* **33**: 475–505.
- Wiens JJ. 2007.** Global patterns of diversification and species richness in amphibians. *The American Naturalist* **170**: S86–S106.
- Wiens JJ, Graham CH, Moen DS, Smith SA, Reeder TW. 2006.** Evolutionary and ecological consequences of the latitudinal diversity gradient in hylid frogs: tree frogs unearth roots of high tropical diversity. *The American Naturalist* **168**: 579–596.
- Wiens JJ, Parra-Olea G, García-París M, Wake DB. 2007.** Phylogenetic history underlies elevational biodiversity patterns in tropical salamanders. *Proceedings of the Royal Society B* **274**: 919–928.
- Wollenberg KC, Vieites DR, Glaw F, Vences M. 2011.** Speciation in little: the role of range and body size in the diversification of Malagasy mantellid frogs. *BMC Evolutionary Biology* **11**: 217.
- Yang Z, Rannala B. 2010.** Bayesian species delimitation using multilocus data. *Proceedings of the National Academy of Sciences of the United States of America* **107**: 9264–9269.

SUPPORTING INFORMATION

Additional Supporting Information may be found in the online version of this article at the publisher's web-site:

Figure S1. Mitochondrial phylogeny of *Thorius* showing only those clades with bootstrap support values > 70 and posterior probabilities > 0.95.

Table S1. Mean values for morphological measurements used in comparative analyses for named species of *Thorius*.

Table S2. GTR distances for 16S between species of *Thorius* used in phylogenetic analyses.

Table S3. GTR distances for cyt *b* between species of *Thorius* used in phylogenetic analyses.

Table S4. GTR distances for ND4 between species of *Thorius* used in phylogenetic analyses.

Table S5. GTR distances for RAG1 between species of *Thorius* used in phylogenetic analyses.